

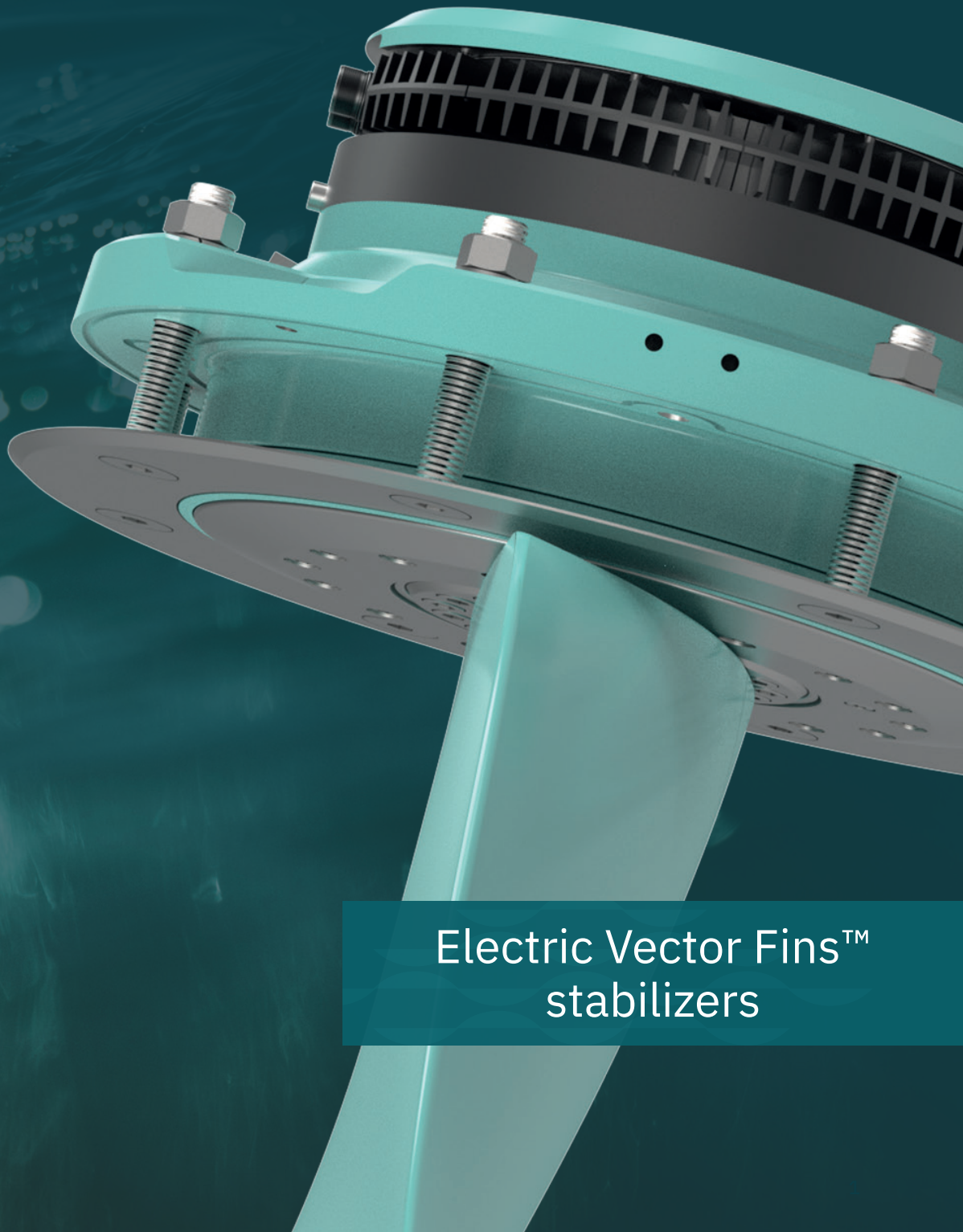

SLEIPNER[®]

Ocean born. Tech bred.



Electric Vector Fins[™]
stabilizers

Electric Vector Fins™ stabilizer system

NEW

A more sustainable choice

Vector Fins™, with their unique and patented design, direct their forces in a much more efficient direction than flat fins for roll stabilization. This benefits stabilization in anchoring and cruising situations. The fins also create lift while cruising, reducing the drag of the boat's hull.

Practically speaking this means that:

- The top speed of the boat will be higher than with flat fin stabilizers
- You will use less fuel than with flat fin stabilizers
- You will consume much less energy from your generator or batteries to achieve the same stabilizing forces at anchor

Quiet operation

The new Sleipner electric actuator solves the challenge of structural born noise from electric or electro-mechanic actuators. The patented solution isolates the moving, mechanical high-torque gears and motor from the boat reducing about 92% of structural born noise.

Sleep on it!

”

The third generation Vector Fins™ typically doubles the stabilizing force per kW input compared to flat fins at anchor.

CEO and Head of R&D
Ronny Skauen

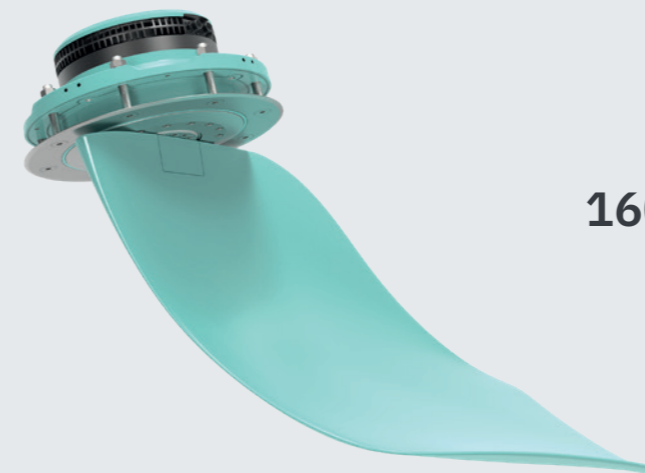

The result of over **1600 installations and 14 years of research.**
Made in Norway.

Significantly more effective

No one can tackle the climate challenges alone, but we can all contribute. The 3rd generation Vector Fins™ are more efficient underway and at anchor. For faster boats the lift from the fins results in improved fuel efficiency compared to flat fins. The fins consume extensively less energy at anchor to achieve the same stabilization level as flat fins. By using the same energy, they stabilize more.



Better for you, better for the environment

- Significantly more stabilizing forces and comfort at anchor
- Effective stabilization from 0 to 40 knots
- Improved speed and fuel efficiency
- Dramatic reduction in known negative side effects with flat fins
- Patented noise cancellation, eliminating up to 92% of structural born noise

It's all about physics

In 2013 Sleipner won the most prestigious award in the marine industry for the invention of the Vector Fins™ stabilizers. The patented, curved shape fins improve every aspect of stabilization compared to flat fins.

Where flat fin stabilization systems waste energy creating unpleasant sideways movements of the boat, Vector Fins™ generates much more vertical forces, which in the end, is what works to stabilize the boat the most effectively.

The same size Vector Fins™ will have the ability to stabilize the yacht in larger waves, or it will stabilize better in similar waves. At anchor, it will feel more comfortable, which is what stabilization is all about, as the boat has less yaw and sway.

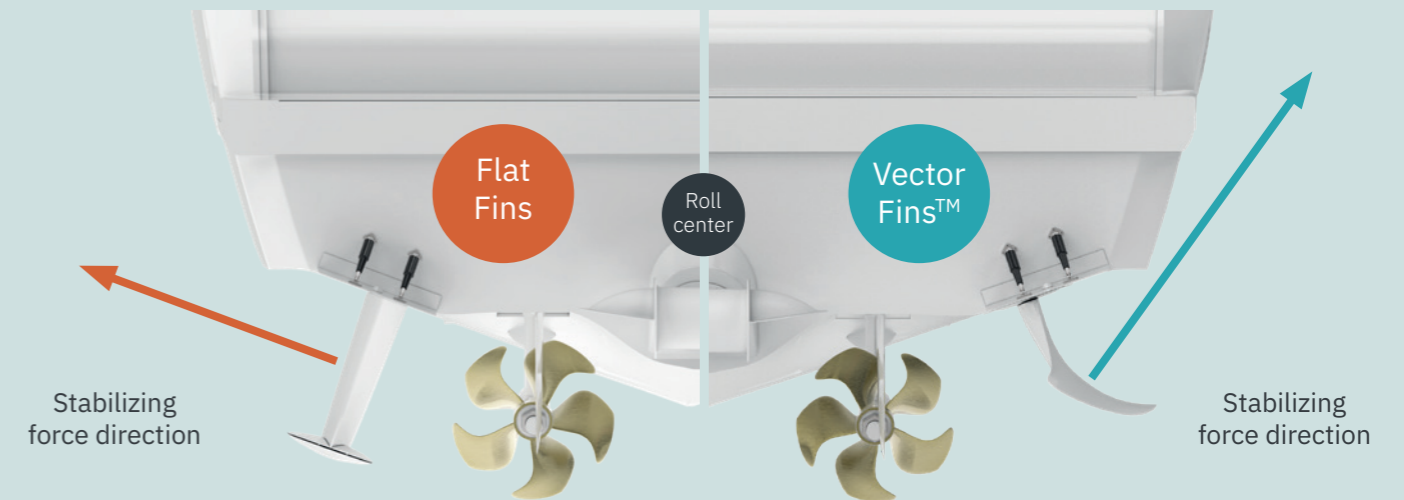

This simplified illustration shows how the Vector Fins™ better directs the fin forces toward the desired vertical direction, minimizing the energy waste of too many forces being used in the horizontal plane, which can cause unwanted side effects such as yaw and sway.

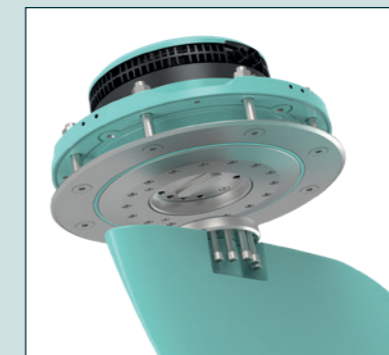

Sleipner electric actuators

The compact design of the actuator is cleverly engineered around a frameless torque motor and a Harmonic Drive strain wave gear. A combination of aluminum, composite, and stainless-steel materials for minimal weight and maximum life expectancy. The gear type is chosen considering the sometimes-extreme loads' fins get in heavy seas and have safety factors and features way above the gear types typically used in electric actuators.

Patented solution for noise cancellation

Another focus has been on noise reduction through its development, resulting in a patented solution reducing 92% of the structural born noise from the actuator. Another benefit is that it reduces peak stress loads on both the gears and the hull.

Only premium brand name components

Integrated lifting points

The complete motor unit can easily be separated from the flange

Patented noise reduction

Easier installation with flange and bolt-lock ensuring a 100% connection

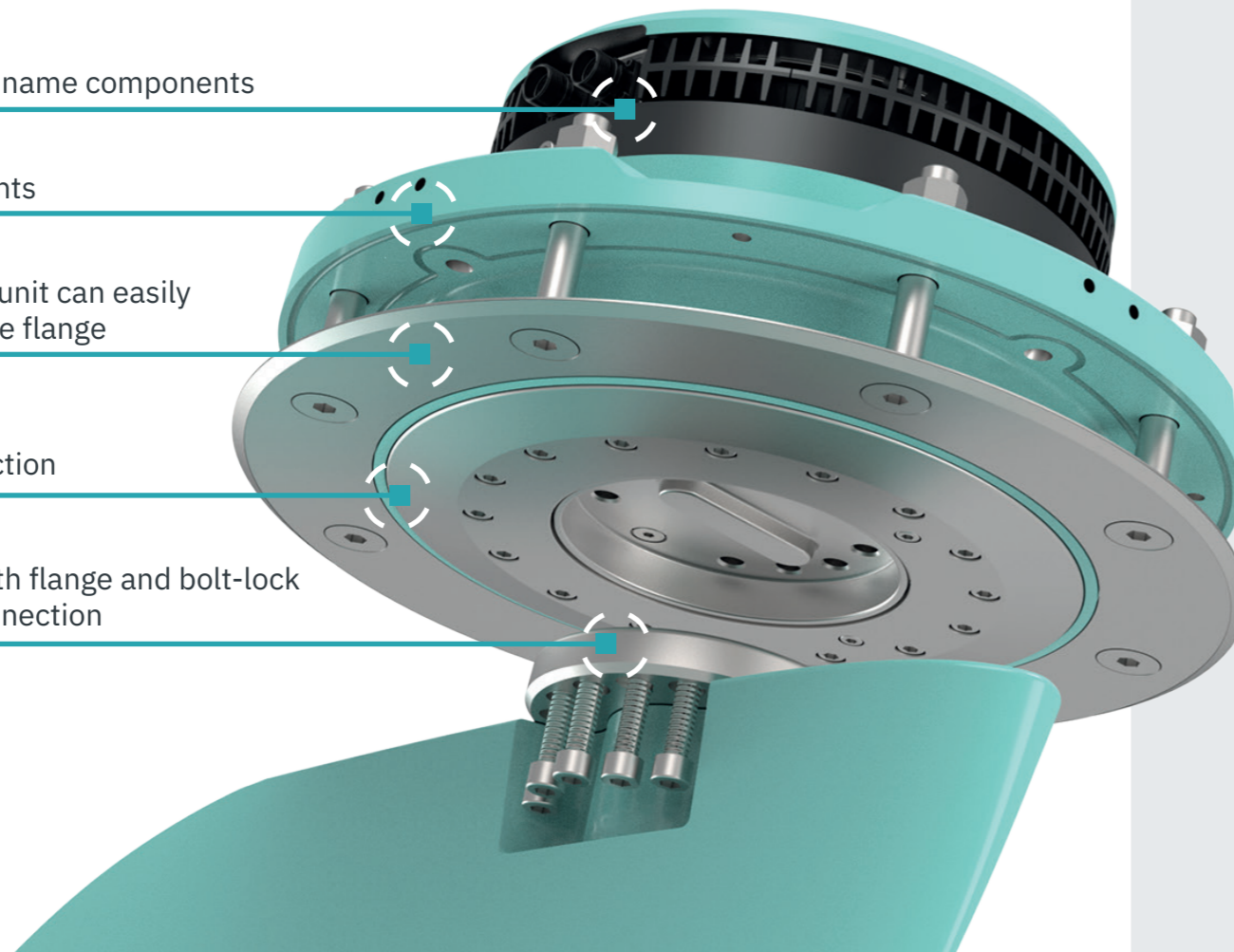

Key features actuator

- Instant on by the press of a button - no start-up period
- Light weight and compact construction
- Ultra responsive and energy efficient brush less motor
- Galvanically isolated design for easy installation in metal hulls
- 24/48V
- 230/400Volt – 1 and 3 phase

Serviceability

- Most parts can be changed on the water
- Motor unit can be removed from base flange in about an hours work
- Integrated lifting points
- Light weight aluminium construction

Stabilization panel and software

- Modern touch screen display prepared for flush installation
- Possibility for remote diagnostics and service through onboard Wi-Fi
- Rudder, gearbox and GPS input for more responsive stabilization
- Controls up to four fins for larger yachts
- Optional integration with MFD's (accessory)



Features

- Dock mode: turn the fin stroke angle more towards the keel when docking longside
- Eco mode: limit power consumption to extend operation time from the battery bank
- DP mode: Analyses gearbox, GPS, and compass heading when operating in Dynamic Position mode to avoid fin lock while reversing in low speed

Electric Vector Fins™

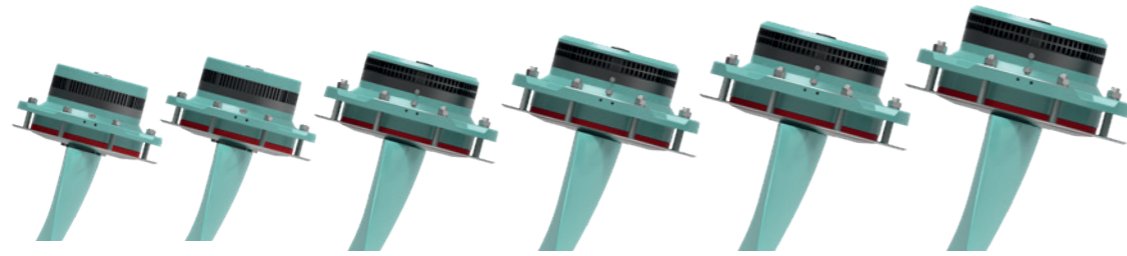

Technical data

Actuator type	SPS40E	SPS50E*	SPS60E	SPS70E*	SPS80E	SPS100E*
Power supply (VDC)	24/48	24/48	48	-	-	-
Power supply (VAC)	-	-	230(1Φ)/400(3Φ)	230(1Φ)/400(3Φ)	400(3Φ)	400(3Φ)
Typical boat size (ft)	45-60	55-70	65-80	75-100	95-125	120-150
Fin model up to 25 knots	V³700	V³900	V³1100	V³1400	V³1700	V³2200
Fin model 25+ knots	V³550	V³700	V³900	V³1100	V³1400	V³1700
Inside hull materials actuator	Aluminium housing					
Outside hull materials actuator	Composite and stainless steel					
Actuator weight (kg)	65	75	118	TBA*	296	TBA*

* Estimated launch in 2024 - please visit www.sleipnergroup.com or contact us for updated information

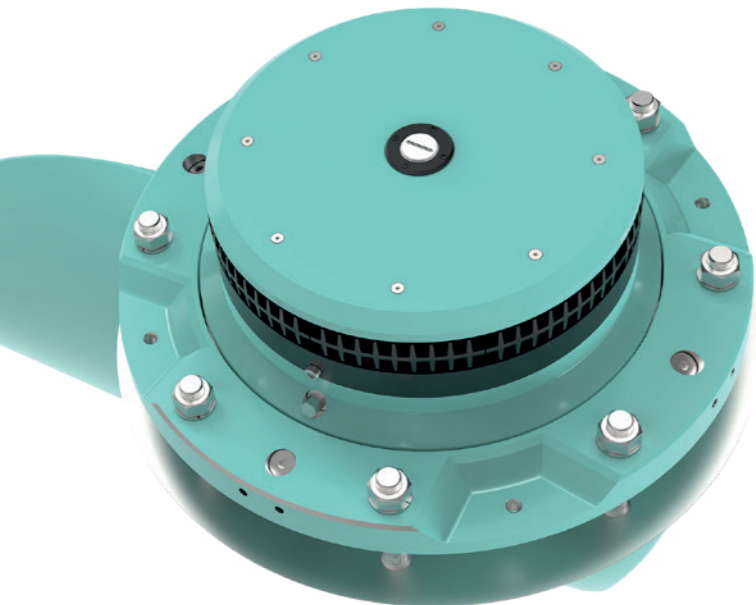

Main features

Any speed stabilizing	Yes
Dock mode	Yes
Eco mode	Yes
Dynamic Position mode	Yes
Patented noise reduction	Yes
Plug and play communication	Yes - S-link™
Thruster communication integration	Yes - S-link™
Galvanic isolated	Yes
4 fin configuration available	Yes
On water service	Yes
Industry leading efficiency	Yes

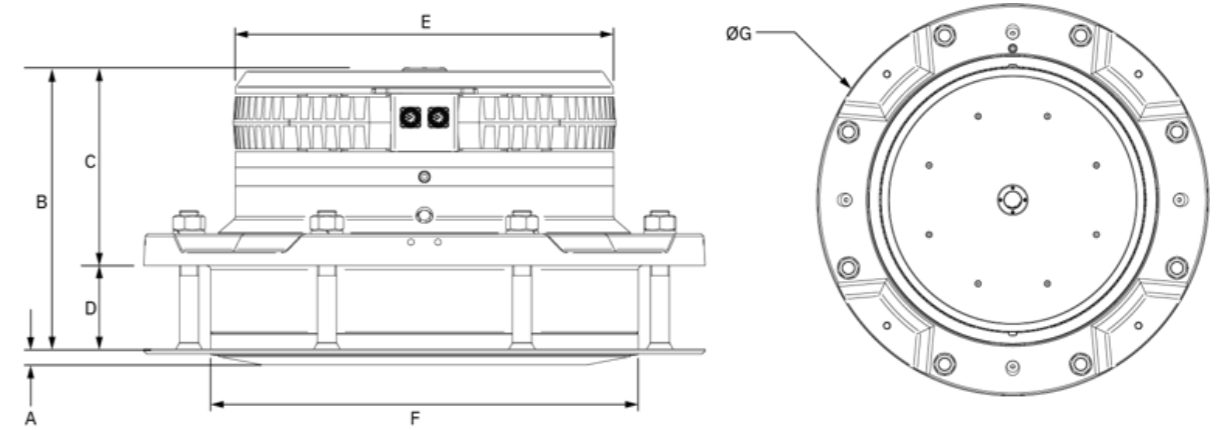

Measurements electric actuators

Code	Description	SPS40E	SPS50E*	SPS60E	SPS70E*	SPS80E	SPS100E*
A (mm)	Actuator height outside the hull	15.8	TBA*	16.8	TBA*	20	TBA*
B (mm)	Total actuator height	223	TBA*	236	TBA*	349	TBA*
C (mm)	Actuator height inside the hull	173	TBA*	172	TBA*	249	TBA*
D (mm)	Hull thickness (sealant included)	50	TBA*	60	TBA*	105	TBA*
ØE (mm)	Diameter of the actuator motor	290	310	350	TBA*	475	TBA*
ØF (mm)	Diameter of the actuator through the hull	340	360	408	TBA*	537	TBA*
ØG (mm)	Diameter of the actuator base	450	TBA*	540	TBA*	705	TBA*

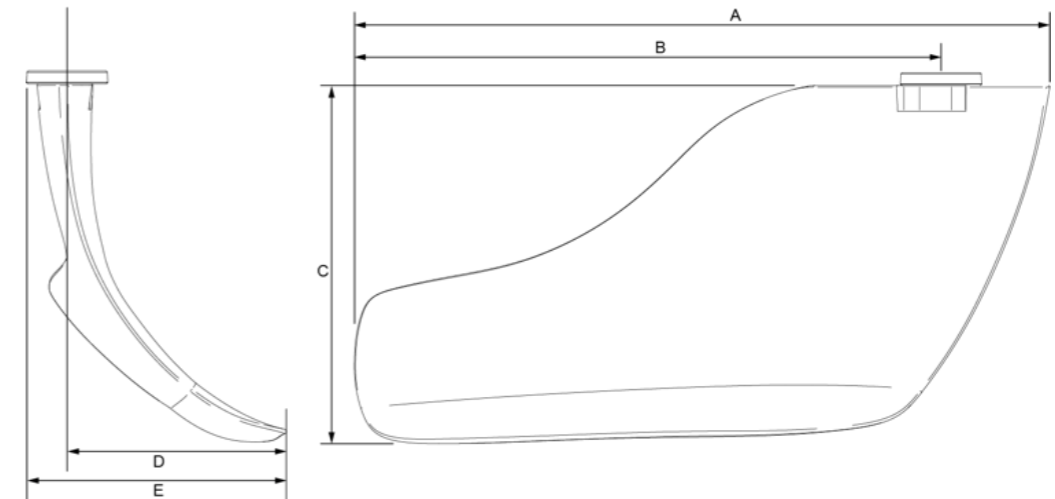

Measurements Vector Fins™

Code	Description	V³550*	V³700	V³900*	V³1100	V³1400*	V³1700	V³2200*
A (mm)	Total fin length	TBA*	1440	TBA*	1750	TBA*	2260	TBA*
B (mm)	Fin length to centre connection	TBA*	1220	TBA*	1490	TBA*	1920	TBA*
C (mm)	Total fin height	TBA*	690	TBA*	850	TBA*	1090	TBA*
D (mm)	Fin with from centre connection	TBA*	430	TBA*	520	TBA*	670	TBA*
E (mm)	Total fin width	TBA*	490	TBA*	600	TBA*	770	TBA*

* Estimated launch in 2024 - please visit www.sleipnergroup.com or contact us for updated information

Please contact us directly for access to more technical data and CAD files
by scanning the QR code or visit www.sleipnergroup.com



© Sleipner Group

Sleipner Group constantly seek ways of improving specifications, design and production. Thus, alterations take place continuously. While every effort is made to produce up-to-date literature, this folder should not be regarded as a definitive guide to current specifications, nor does it constitute an offer for the sale of any particular product. All images used are for illustrative purposes. Alterations to actual product may occur.