



Installation Guide

For DC Electric Thruster Models
SE300



DOCUMENT ID: 7333

REVISION: 06

DATE: 2024

LANGUAGE: EN

MI

Contents

Installation Manual

Responsibility of the Installer	3
General Installation Consideration and Precaution Guidelines	3
Product Measurements	4
Product Specifications	4
Positioning of the tunnel / thruster	5
Tunnel Length	6
Tunnel Installation in Sailboats	7
Water Deflection	8
Tunnel Ends	9
Tunnel Installation	10
Stern Tunnel Installation	12
Gear Leg & Motor Bracket Installation	13
Propeller Installation	16
Motor Installation	17
Electrical Installation	18
Motor Lug Connection	18
Electrical Reference Guide	19
Technical Wiring Diagram	19
Control Panel Installation	21
Post Installation Checklist	22
Service and Support	23
Product Spare Parts and Additional Resources	23
Warranty Statement	23

Warnings and Safety

MC_0800

It is essential to follow all instructions within this document to avoid potential personal injury, death, or damage to existing products in the vessel, the vessel's hull integrity, and including this product during installation or operation. Failure to follow instructions within this document will render all warranties given by Sleipner Motor as VOID.

Warnings and situations requiring extra caution are outlined in the documentation. Take extra consideration when warnings are outlined.



WARNING

Indicate a potentially hazardous situation that, if not avoided, could result in death or severe injury.



CAUTION

Indicates a potentially hazardous situation that could result in minor or moderate injury or critical damage to vessel integrity if not avoided.

MC_0020

General:

- The installer must read this document to ensure necessary familiarity with the product before installation.
- Directions outlined in this document cannot be guaranteed to comply with all international and national regulations, including but not limited to health and safety procedures. It is the installer's responsibility to adhere to all applicable international and national regulations when installing Sleipner products.
- This document contains general installation guidelines intended to support experienced installers. Contact professional installers familiar with the vessel and applicable regulations if assistance is required.
- If local regulation requires any electrical work to be performed by a licensed professional, seek a licensed professional.
- When planning the installation of Sleipner products, ensure easy access to the products for future service and inspection requirements.

For Sleipner thruster systems:

MC_0425

- Do not install the thruster system in any position that requires modifying the stiffener/ stringer/ supports, which may jeopardize the hull integrity. Consult with the boat builder to see if this can be done safely if absolutely necessary.
- Never run the thruster out of water without load. Without load or resistance, the thruster propeller RPM will reach extremely high speed, damaging the system.
- The thruster motor must be handled with care. Do not rest the thruster on its drive shaft, as its weight can damage it.

For on-board electric motor driven systems:

MC_0031

- Ensure motors installed in small compartments are dry and well-ventilated to allow the electric motor to cool.
- The electric motor, components, and cables must be mounted to remain dry.
- The electric motor can reach over 100°C before activating the temperature switch. Any loose items near the thruster motor are a potential fire hazard and can cause short-circuiting.
- The thruster power supply circuit must include the recommended sized fuse and a battery isolation switch.

For DC electric motors:

MC_0426

- The electric motor will generate some carbon dust. Storage compartments must be separated from the thruster to prevent nearby items becoming dirty. **(NB: IP version motors generate dust but are enclosed.)**

For lithium batteries for on/off thruster systems:

MC_0501

- High capacity lithium batteries are capable of supplying a higher operating voltage to the motor than the on/off thrusters are rated for. Running thrusters at higher than rated voltage will reduce operating time, increase wear and damage the thruster. Operating the thruster outside specified ratings will void warranty.

Dimension code	Dimension description	mm	inch
ID	Internal tunnel diameter	300	11,81
H	Height	457	17,99
W	Width	350	13,78
L	Length	274	10,79
WD	Water Depth	300	11,81
TL	Minimum tunnel length	273	10,75
TL	Recommended tunnel length	333	13.11
T (min)	Minimum tunnel wall thickness	10	0,39
T (max)	Maximum tunnel wall thickness	12	0,47

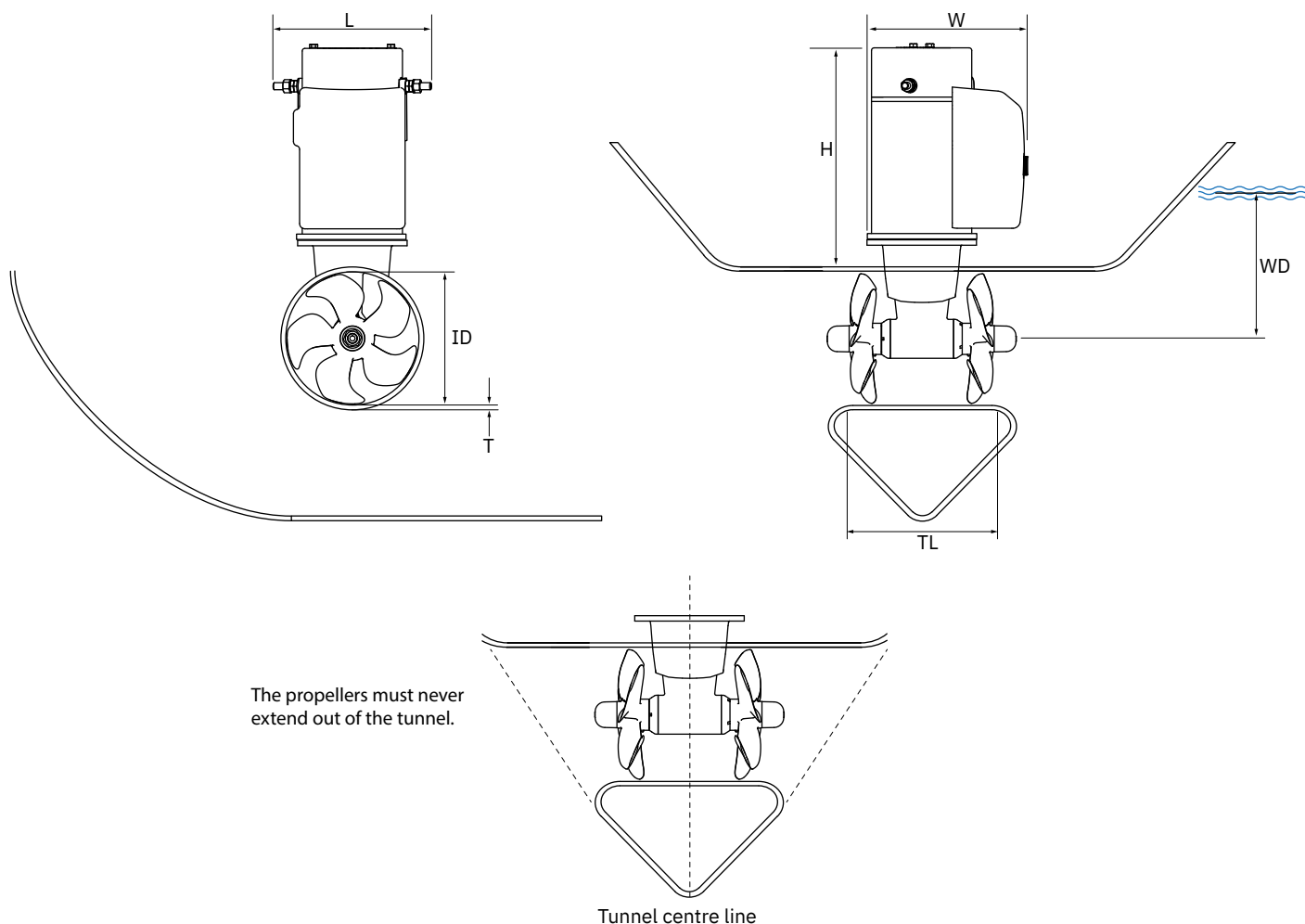

MG_0075

Product Specifications

MC_0140

Product	Maximum Operating Voltage *	Thrust		Power Output	Weight	Typical run time at max thrust
		48VDC *	42VDC *			
SE300 48V	48V	340 kg / 749 lbs	300 kg / 661 lbs	15 kW / 20 hp	73 kg / 160 lbs	2-3 min at 20°C ambient

*Measured at the motor terminals when running the thruster

1. Aim to install the thruster as far forward as possible

Due to the leverage effect around the boats' pivot point. The distance difference from the boat pivots' point to the thruster will determine the amount of real rotation power for the boat.

2. Aim to install the thruster as deep as possible under the waterline

Deeper installations prevent air from being sucked into the tunnel from the surface, resulting in reduced thrust performance and increase noise levels during operation. Deeper installations increase water pressure for maximum efficiency from the thruster.

The centre of the tunnel should be as a general rule minimum of 1 x the tunnel diameter below the waterline. **(NB: Refer to product measurements to define your products recommended depth below the waterline.)** The installer must make evaluations based on thruster performance, boat type and operating conditions. As a general recommendation, the position of the tunnel should not be a minimum of 1/4 of the diameter of the tunnel from the boat keel. **(NB: This can be overlooked depending on the installation methods defined in this manual.)**

1

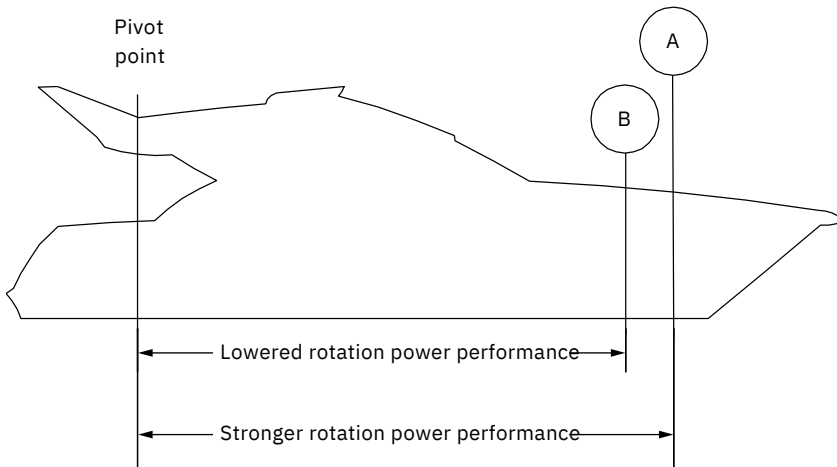

2

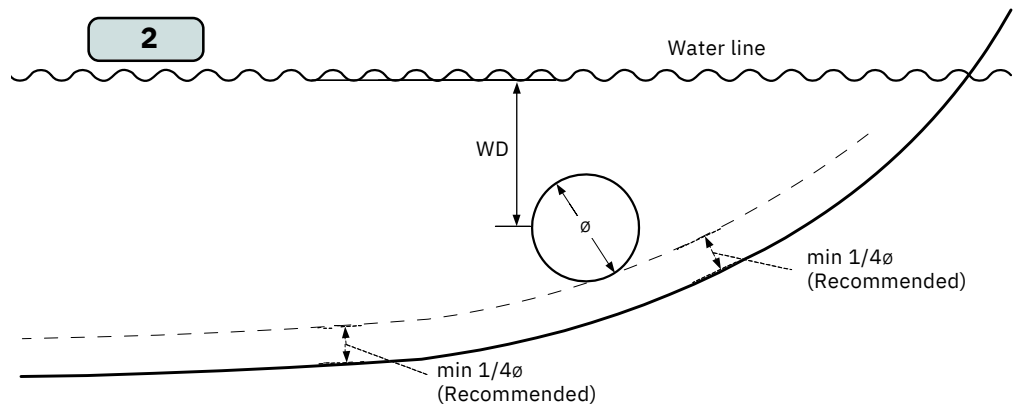

Optimal tunnel length

Achieving the correct tunnel length depends on many factors from the hull type, operation and environmental conditions.

Tunnels should avoid being longer than 4 x the tunnel diameter as this will reduce thruster performance. **(NB: Installing long length tunnels can flex/bend over time and may require additional support. Consult with a naval architect.)**

1. Do not allow the variable length of the tunnel walls to vary in length excessively.
EG. The top tunnel wall is x 4 longer than the bottom wall.
2. If the tunnel is too long, the friction inside will reduce the water speed and thereby the thrust.
3. If the tunnel is too short (typically only in the bottom section of the tunnel) cavitation problems can occur as water flow will not be able to "straighten" itself before reaching the propeller. This cavitation will reduce performance and increase noise during operation.

Thruster within the tunnel

It is important the propellers and the lower unit/ gear leg must be entirely inside the thruster tunnel. Propellers that protrude from the tunnel will not perform as intended.

4. Standard Use

Tunnel length must be long enough to ensure the propellers are not extruding the tunnel. **(NB: Refer to product measurements to define your products recommended tunnel length.)**

5. Flat Bottom Hull

Tunnel lengths must be longer than the standard measurement outlined within the manual to ensure a circular vacuum is not created between the thruster and the bottom of the boat.

6. High-Speed Boats

Tunnel lengths must be increased to protect the propeller from damage when crashing against the water surface during high-speed cruising. **(NB: This can include the length of a spoiler)**

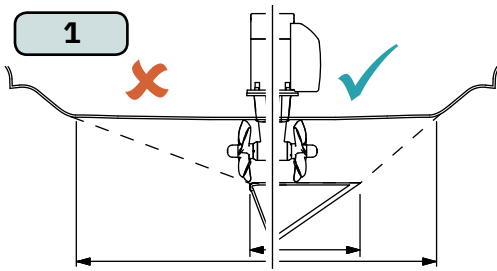

Do not allow the variable length of the tunnel walls to vary in length excessively.
EG. the top tunnel wall is x 4 longer than the bottom wall.

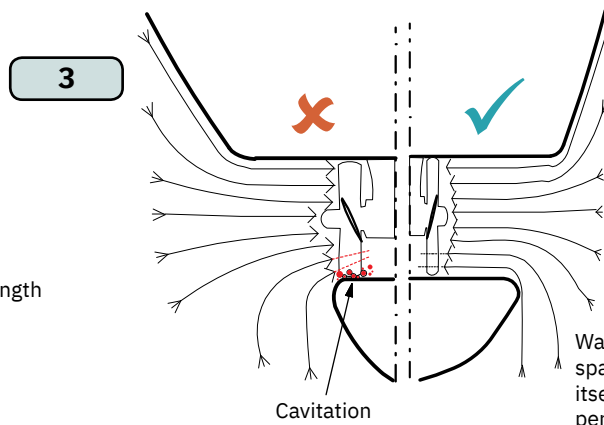

Water flow must have space to "straighten" itself for best performance.

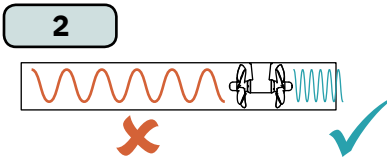

4 STANDARD USE

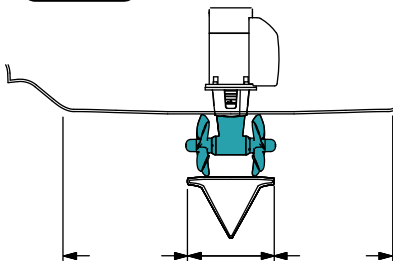

The gear leg/ propeller(s) must never extend out of the tunnel

5 FLAT BOTTOM HULL

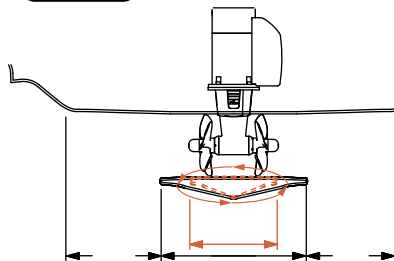

Increase tunnel length to prevent a circular water vacuum cavity between the propeller and the hull of the boat.

6 HIGH-SPEED OPERATION

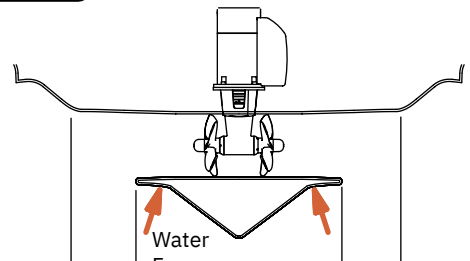

Increase tunnel length to protect the propeller from water forces when high-speed cruising.

MG_0048

Some sail boats have a flat bottom and shallow draft in the bow section. This can make installing the thruster as far forward from the boats main pivot point difficult.

However, it is possible to install a tunnel thruster in most sail boats, even when the hull does not directly support the fitting of a tunnel.

Instead fit the tunnel halfway into the underneath section of the existing hull. Strengthen it with a deflector/ spoiler directing the water flow around the tunnel. This will allow installation of the thruster in the proper position on the boat, maintaining the reliability and space advantages of the tunnel thruster.

This installation is being used by some of the world's largest sail boat builders and has proven to give little to no speed loss during normal cruising. This can also be an installation method for flat bottomed barges to avoid extremely long tunnels and large oval tunnel openings in the hull.

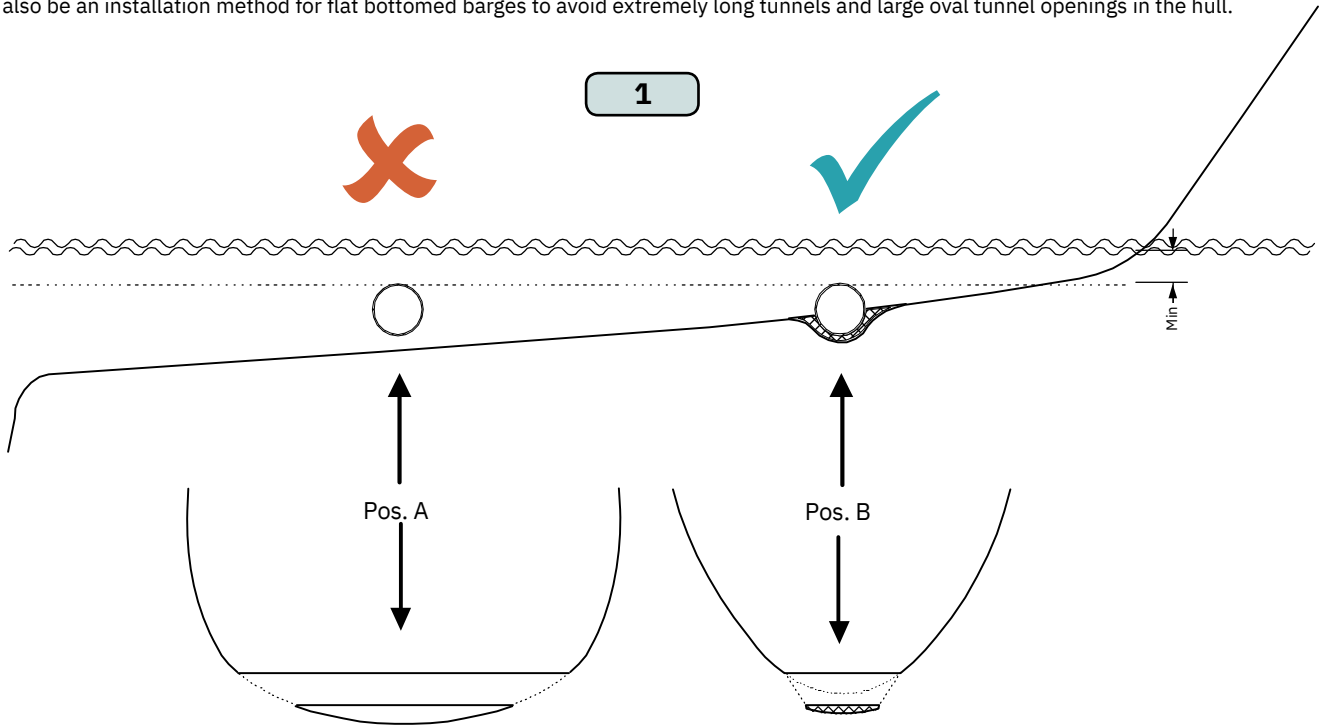

1. A possible problem in sail boats or fast powerboats is that a non-rounded surface can generate drag from the back face of the tunnel, as it creates a "flat" area facing the flow of water.

This problem can be solved in two different ways, depending on what is possible or easier to perform.

2. The best solution which generally reduces the most drag is to make a recess in the hull at the back of the tunnel. As the back face is removed water can flow freely past the tunnel entry. The depth and shape of this recess will depend on the boat and the angle facing up/ down aft of the tunnel insert. Normally it is angled slightly down because of the water flow on this area.
3. Making a deflector/ spoiler in front and underneath the tunnel can also reduce damage to the thruster and drag. The deflector/ spoiler will push the water flow out from the hull so water can pass by the back face of the tunnel. The shape and size of this deflector/ spoiler will depend on the hull shape. The easiest way of making the deflector/ spoiler is to retain a part of the lower forward area of the tunnel while installing the tube. Use this area as support to mould a soft curve/spoiler shape from the hull.
4. The thruster propeller can spin (passively) producing noise while sailing or cruising as water is forced through the tunnel. Water-flow directed through the tunnel at high speeds, during turning or as the boat bumps waves while underway can also damage the thruster.

(NB: As a rule, you should not see the back face of the tunnel when standing directly in front of the boat looking aft.)

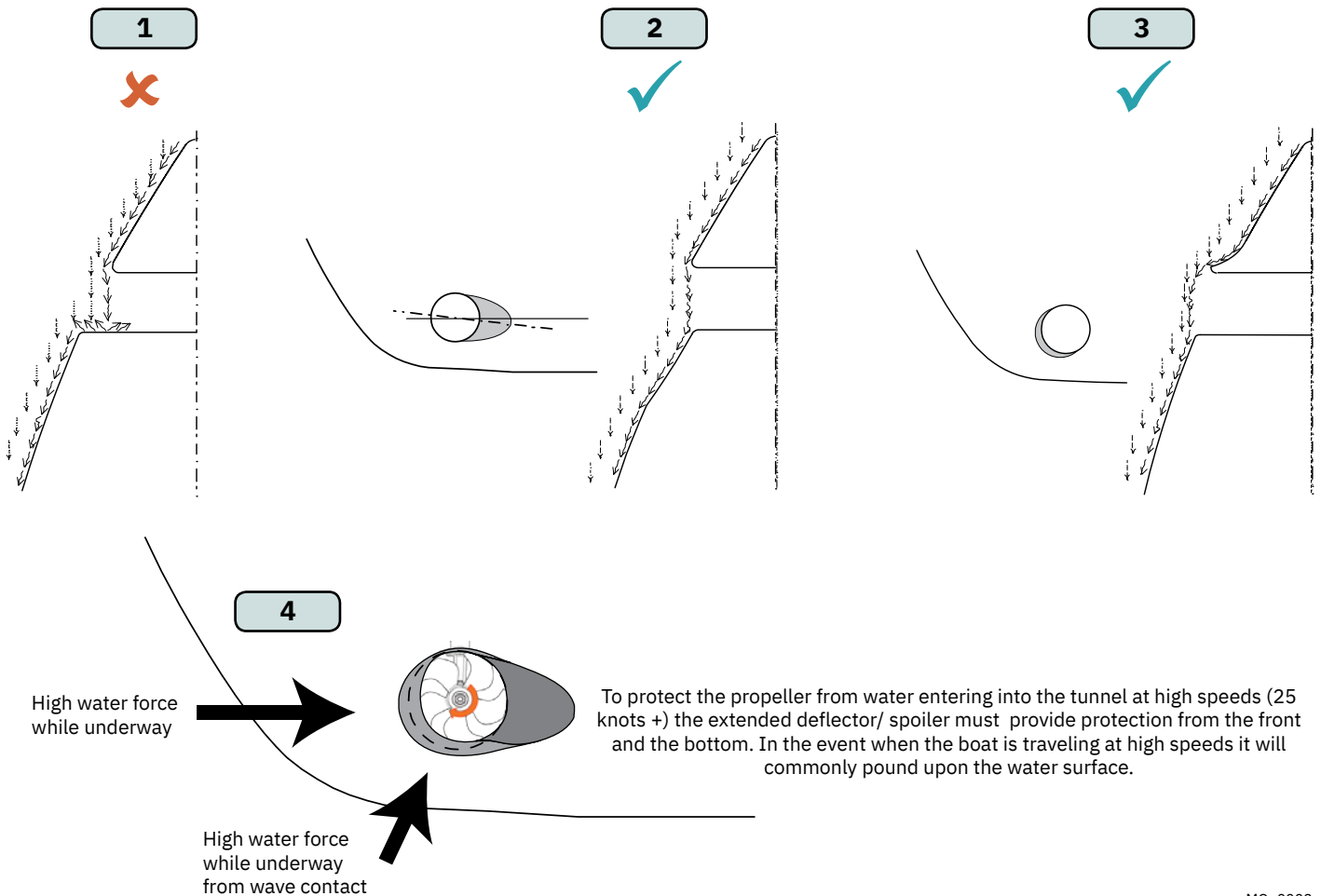

Rounded tunnel ends will maximise thrust and minimise noise and cavitation.

For best performance round the tunnel connection to the hull-side as much as possible. The minimum rounding has a radius of 10% of the diameter of the tunnel.

Significant advantages of a rounded tunnel over a sharp tunnel to hull connections are:

1. A rounded tunnel end will prevent the creation of turbulence/ cavitation created from a sharp tunnel end when water passes by the tunnel.
 - The turbulence/ cavitation will block the outer area of the tunnel and thereby reduces the effective tunnel diameter and thrust.
 - Turbulence/ cavitation on the propeller will lessen the thrusters performance and create excess noise.
2. For steel/ aluminium hulls angled tunnel ends also offer similar performance as a rounded connection.
3. A rounded tunnel end makes the thruster draw water from along the hull-side, creating a vacuum that will suck the boat sideways and thereby give additional thrust.
 - With a sharp tunnel end, the thruster will be unable to take water from along the hull-side, and you will not gain the desired vacuum and additional thrust. This “free” extra thrust in optimal installations be 30 - 40% of the total thrust.

(NB: A Slooper thruster propeller does not produce cavitation at working speed. Therefore, any cavitation and cavitation noise in the tunnel will be caused during improper tunnel installation.)

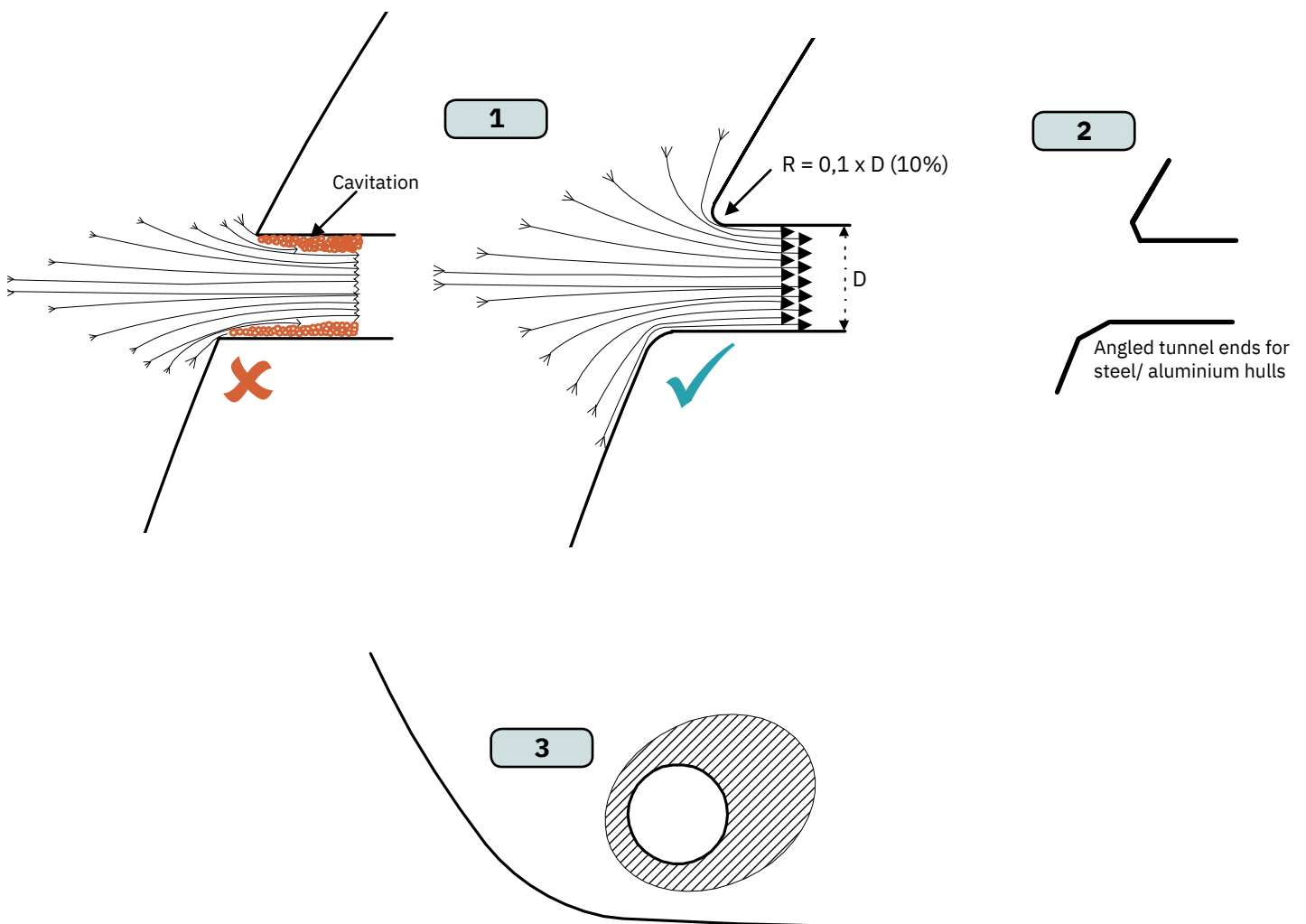

The following are only general instructions and do not explain in any way the details of fibreglass work. Problems caused by faulty installation of the tunnel, are the installers full responsibility. Seek a professional boat builder when modifying the hull.

1. Find the position in the boat considering the information earlier in this manual and the applicable measurements for the thruster model you are installing. Mark the centre of the tunnel on both sides of the hull. Drill a hole horizontally at these marks.
2. Mark the circle for the tunnel opening (outside diameter of the tunnel) and cut the hole.
3. Grind off the gel coat to the "real fibreglass" area 12cm around the hole on both inside and outside the hull to cast the tunnel to the hull (**Fig. 3**).
4. Insert the tunnel and mark its shape to fit the hull. (**NB: if you are installing with a deflector/ spoiler, leave a part of the tunnel in the front and underside of the tunnel that will cover the back face.**)
5. Cut the tunnel ends to the desired shape and lightly sand its surface. Clean the area with acetone or similar where you are going to apply fibreglass. (**NB: Do not cast or add fibreglass to the area were the thruster will be placed.**)
6. Cast the tunnel to the inside of the hull, use at least eight layers of 300g fibreglass and resin, preferably alternating mat and rowing types of fibreglass. To round the tunnel ends to a 10% radius make further layers inside to preserve the desired hull thickness.

(NB: Ensure gaps between the tunnel and the hull are completely filled with resin/ fibreglass. In areas where you can not access to make layers of resin/ fibreglass, a resin/ fibreglass mixture must be used in that area.)

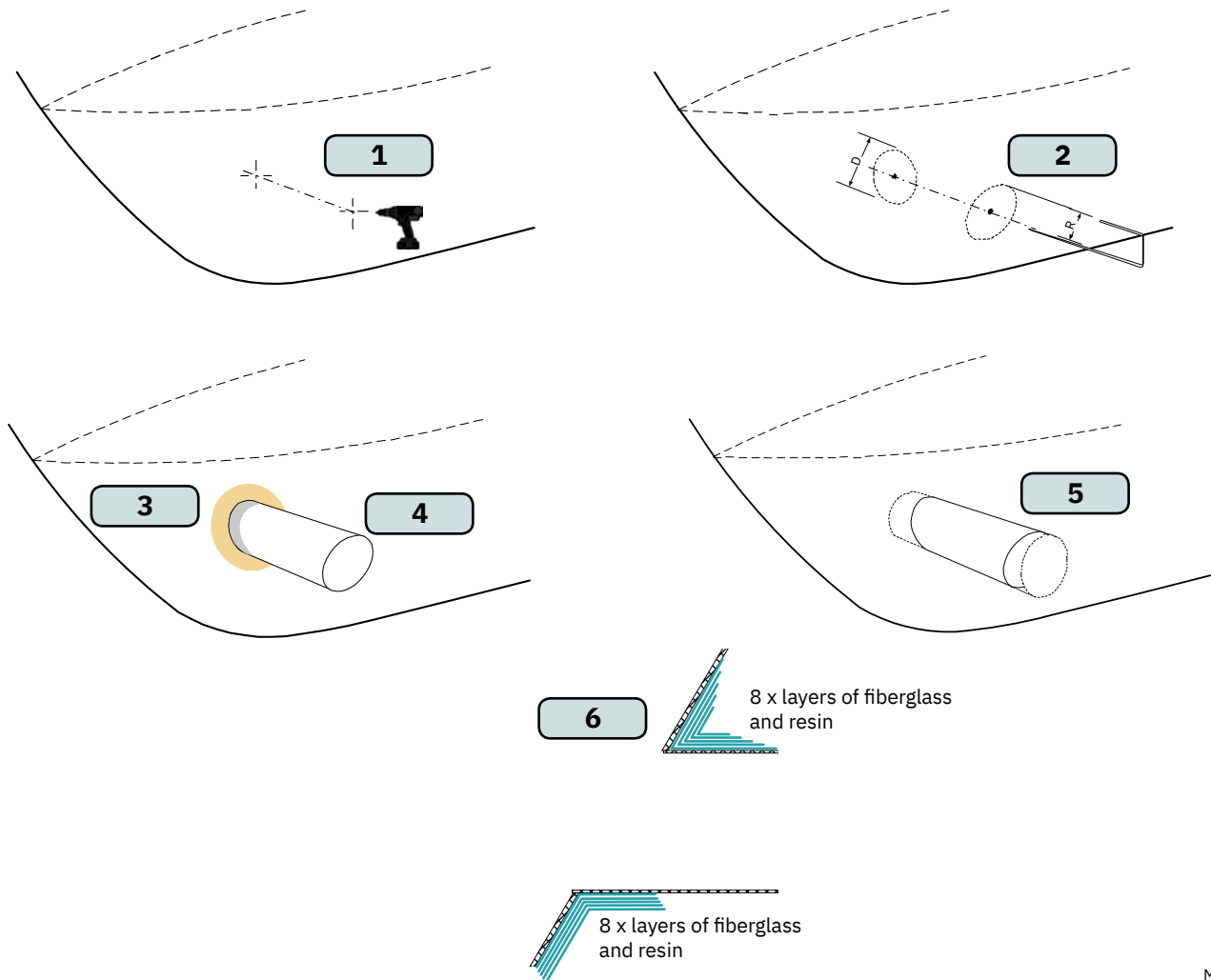

With tunnel installed and cast.

1. Round the edges with a radius of 10% of the tunnel diameter.
2. For steel/ aluminium hulls make a slope with a length of 10-15% of the tunnel diameter. **(NB: If this is not possible, round the tunnel end as much as possible.)**
3. Additionally cast two layers on the outside of the tunnel/ hull in a 10cm area
4. Follow the same method if making the deflector/ spoiler.

You must apply gel coat to areas you have grounded/ moulded to make waterproof. These areas allow water access to the hull which is typically not waterproof without these applications outside. **(NB: All original Sleipner tunnels are fully waterproof when delivered except in the areas where you have cut and bonded it to the hull.)**

Avoid all casting where the motor-bracket is to be placed, as this will cause misfit and possible failure to the gear house.

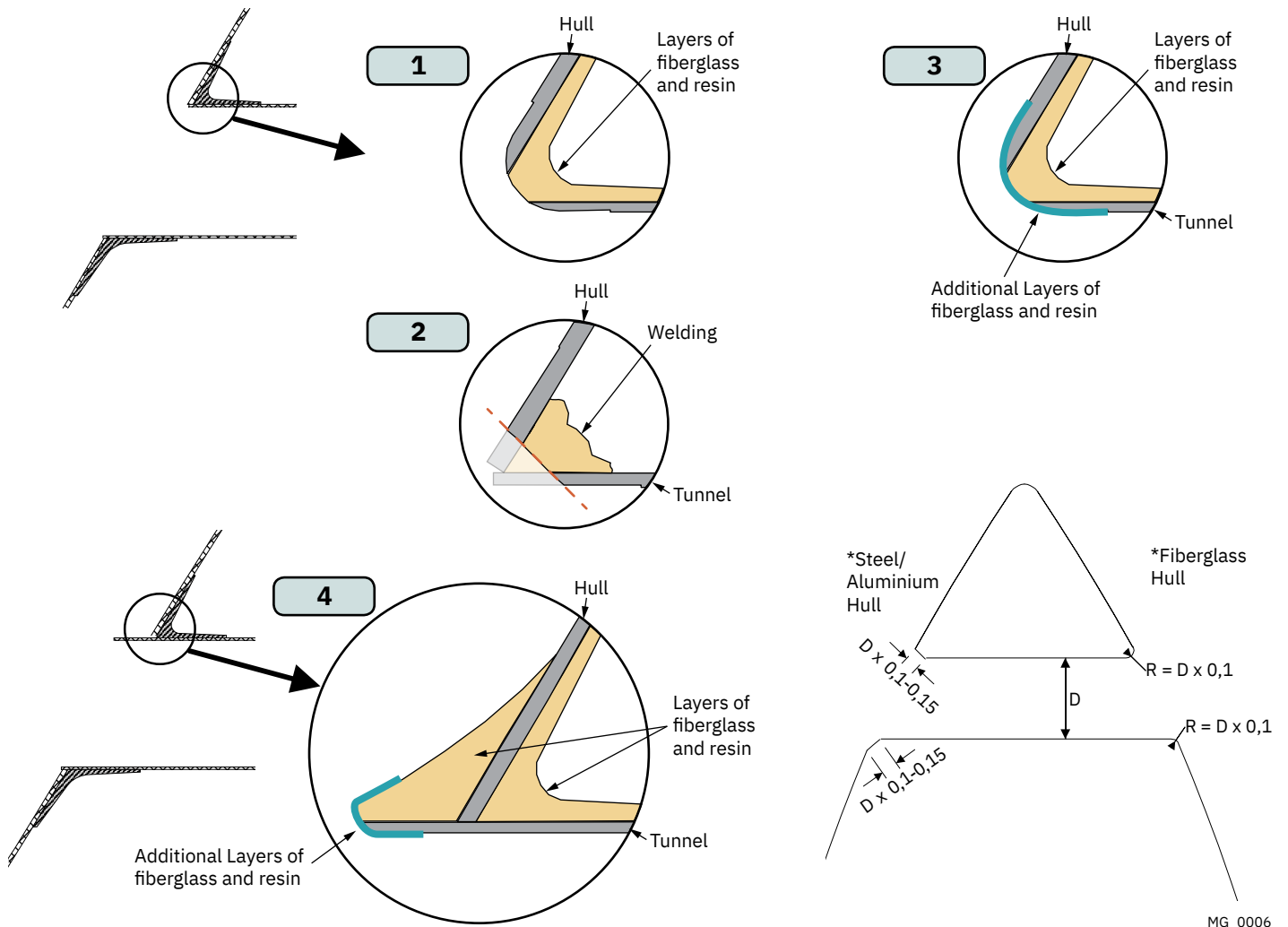

For **Stern Thruster** installation please refer to the supplied manual in your Sleipner product delivery



For supporting stern tunnel installation documentation, we advise you to visit our website www.sleipnergroupp.com and find your Sleipner stern tunnel model.

Please refer to the graphic for special considerations relating to your model

1. Mark the tunnel centreline and the boat's centreline. **(NB: Install the gear leg and propeller as shown for the thrust direction to correspond with the control panel. Position gear leg with the P-mark facing port and the S-mark facing starboard.)**
2. Use the gasket or template (recommended) to mark the hole centres and double-check the measurements. The centre hole MUST be placed using the boat centreline as shown. **(NB: All holes must be in-line with the tunnels' centreline for correct installation, clearance between the propeller and the tunnel is minimal.)**
3. Drill the main centre hole followed by the two screw-holes.
4. Smooth the surface of the tunnel. A rough surface will cause possible failure/movement of the gear leg. The motor bracket must rest steadily on the tunnel.

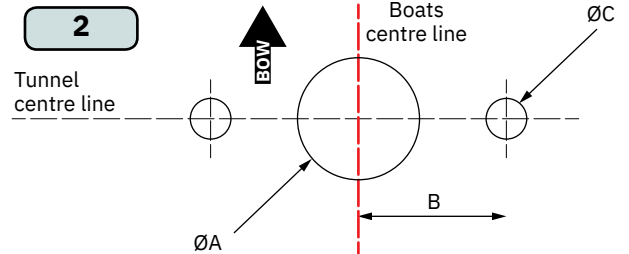
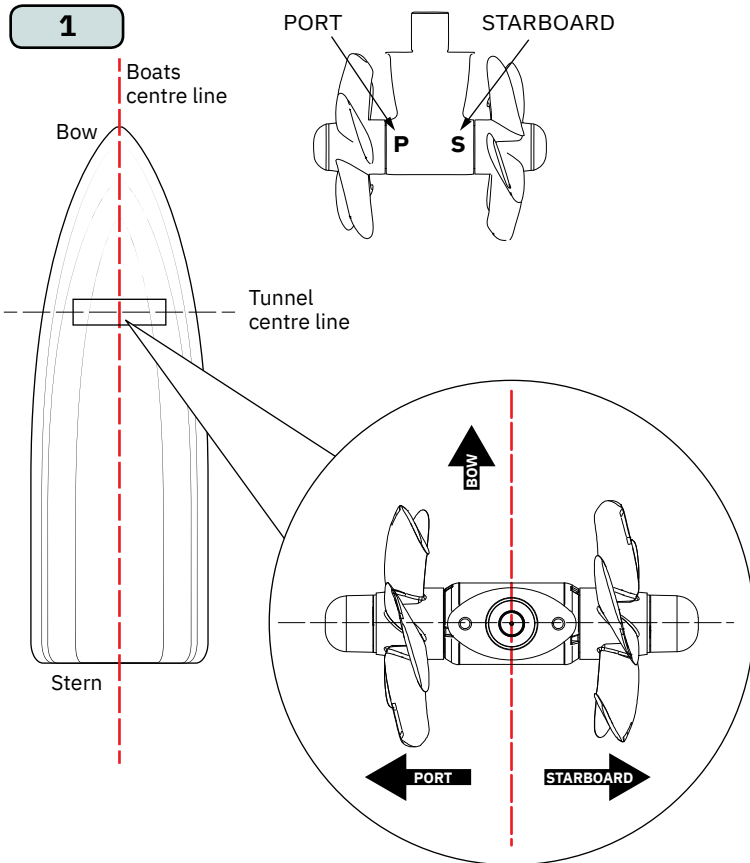

Models	Measurements					
	ØA		B		ØC	
	mm	inch	mm	inch	mm	inch
SE/SEP/SE IP/SEP IP 80/185T	32	1.3	28	1.1	9	0.4
SE/SEP/SE IP/SEP IP 100/185T						
E100/185T						
SH100/185T						
SE/SEP/SE IP/SEP IP 120/215T	46	1.8	40	1.6	11	0.4
SE/SEP/SE IP/SEP IP 130/250T						
SE/SEP/SE IP/SEP IP 170/250TC						
SE/SEP/SE IP/SEP IP 210/250TC						
E130/250T						
E150/215T						
E170/250TC						
E210/250TC						
E240/250TC						
SH160/215T						
SH240/250TC						
SAC 240/250TC						
SE/SEP/SE IP/SEP IP 250/300TC	51	2	48	1.9	11	0.4
SE/SEP/SE IP/SEP IP 300/300TC						
E250/300TC						
E300/300TC						
SH300/300TC						
SH320/300TC	67	2.6	48	1.9	11	0.4
SH360/300TC						
SH400/300TC						
SAC360/300TC						
SAC400/300TC	83	3.3	70	2.8	17	0.7
SH420/386TC						
SH550/386TC						
SH700/412						
SAC450/386TC						
SAC520/386TC						
SAC700/412						

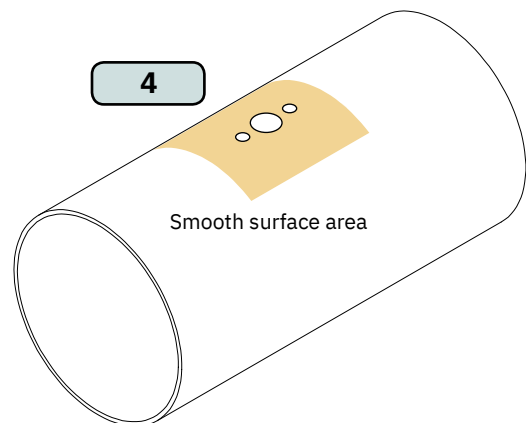
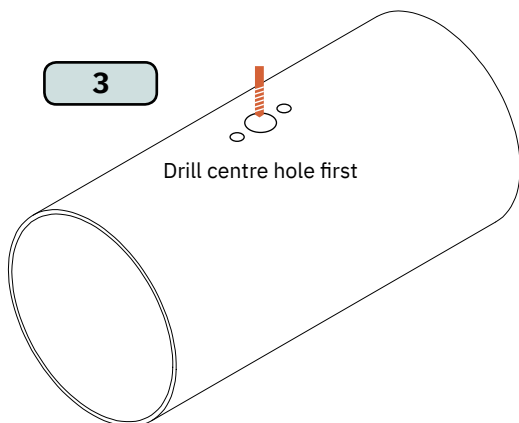

Please refer to the graphic for special considerations relating to your model

5. Place the gear leg (without the propeller) with the gasket on inside the tunnel.
6. Place the propeller on the gear leg (**NB: Do not secure the propeller with securing parts**) to ensure it is centred and rotates freely with the same clearance from each blade to the tunnel wall.
7. Place top motor bracket and bolt plate to measure the drive shaft has come through the motor bracket at the correct height. Remove the gear leg and propeller for final installation.

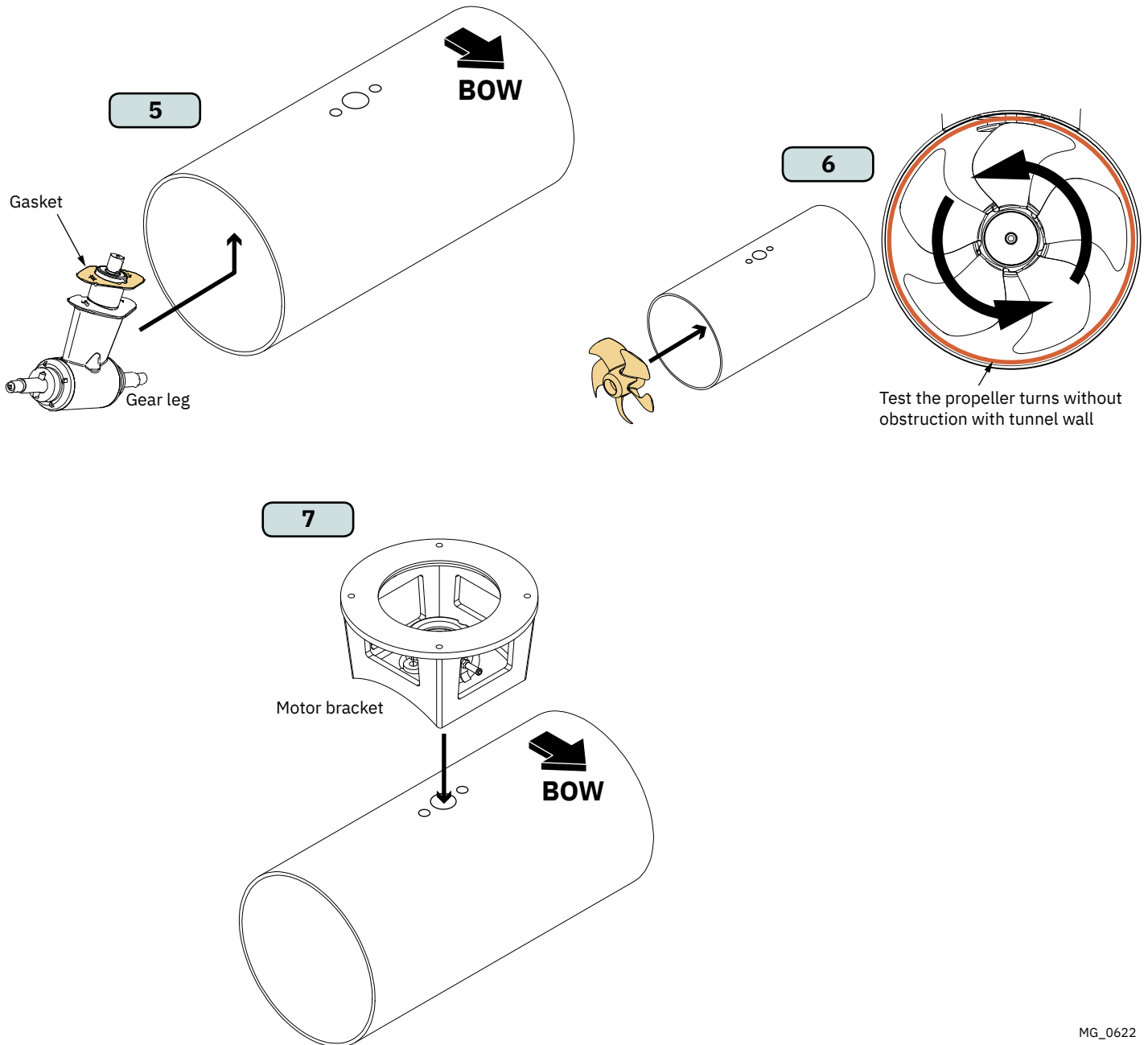

Gear Leg & Motor Bracket Installation

MC_0001

Please refer to the graphic for special considerations relating to your model

8. Apply appropriate sealant to both sides of the gasket and place on the gear leg. Place the gear leg in the tunnel (without the propeller). Use appropriate sealant to ensure that no leakages occur. **(NB: See your sealant data sheet for the correct application process.)**
9. Install the top motor bracket and gear leg gently together.
10. Fasten the gear leg and the motor bracket with the bolts provided. Tighten to torque as shown.

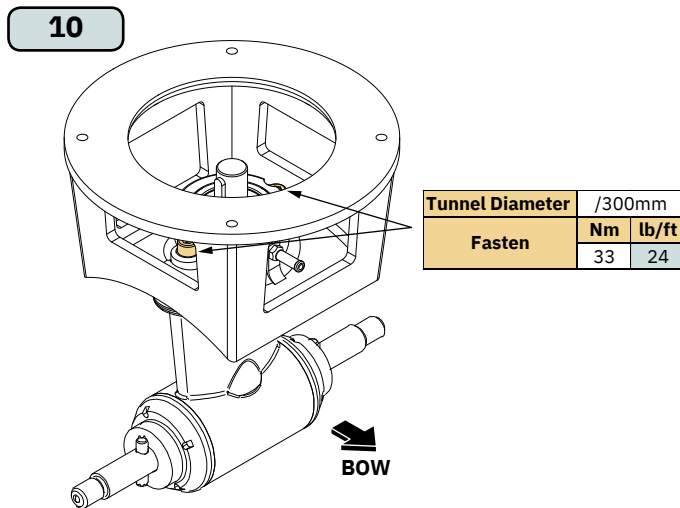
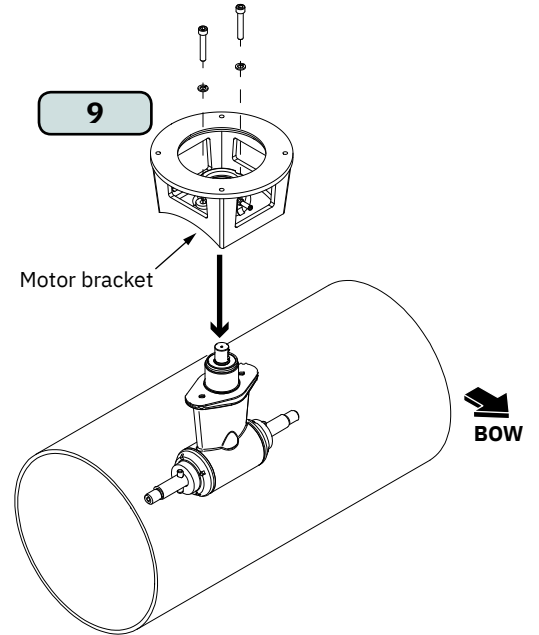
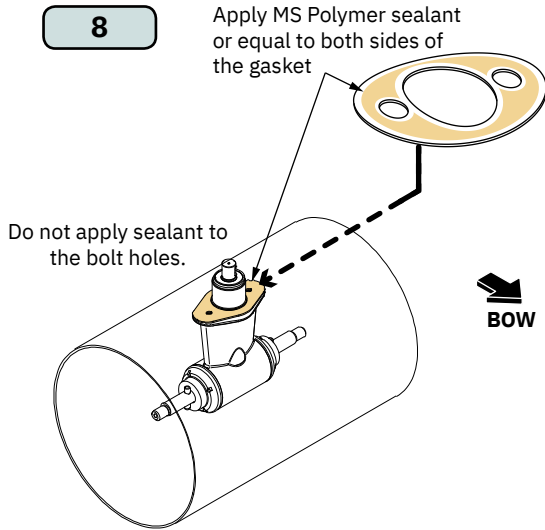

MG_0621

Please refer to the graphic for special considerations relating to your model

1. Centre the drive pin and insert the propeller onto the shaft spline. Rotate the propeller until the drive pin aligns with the internal slot in the propeller.

(NB: For twin counter-rotating gear legs, propellers are marked with P (Port) and S (starboard) and must be installed appropriately.)

2. Insert the washer to the end of the shaft spline. Tighten with the propeller lock-nut.
3. Insert the anode to the end of the propeller and tighten the anode holding screw. Apply a thread glue (Loctite 243 or similar) to ensure that the anode holding screw does not unscrew itself from during the rotation of the propeller.
4. Apply anti-fouling to the gear leg and propeller. Do not apply anti-fouling to any rubber elements of the gear leg or anodes.

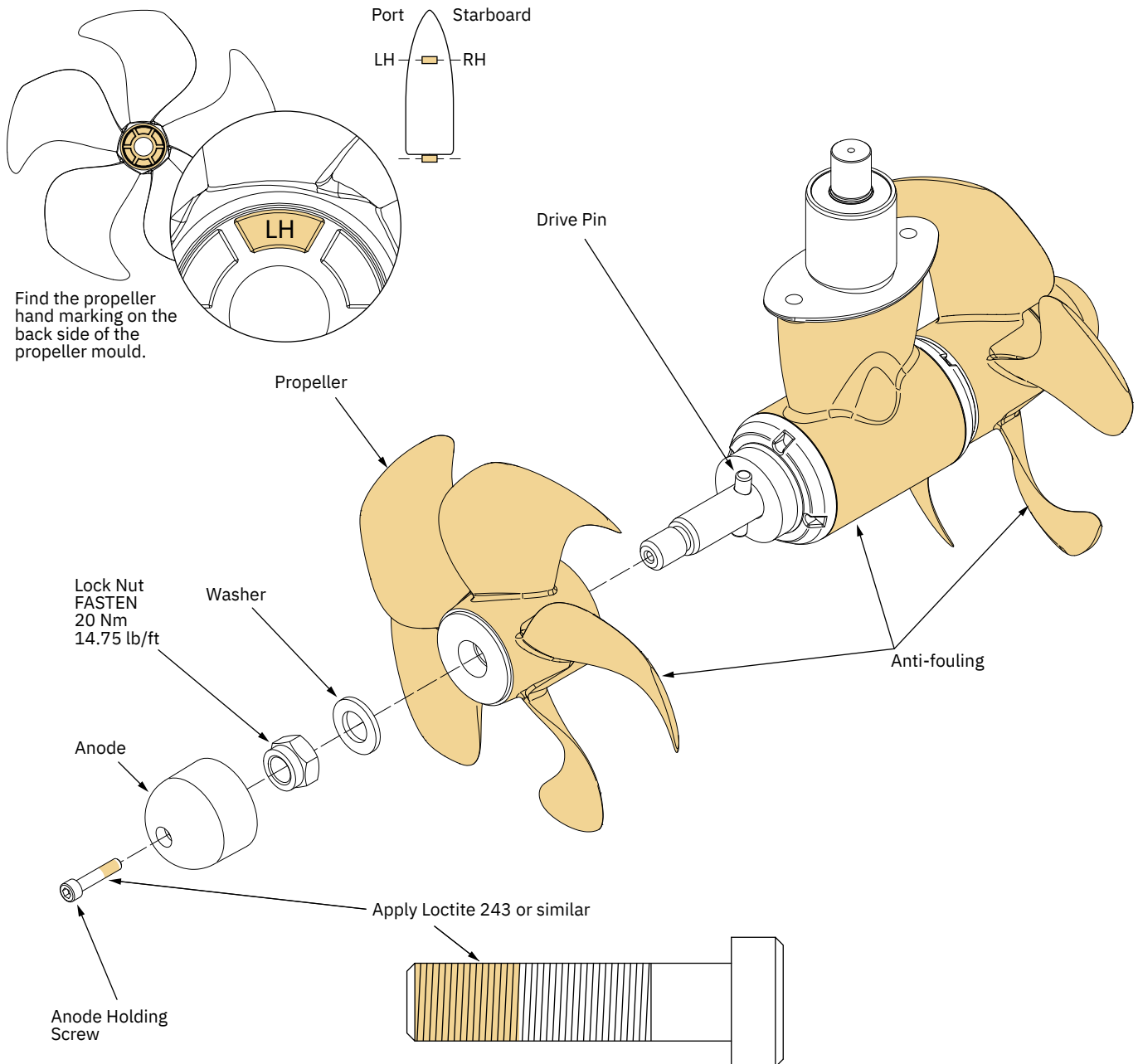

Please refer to the graphic for special considerations relating to your model

1. Install the motor onto the motor bracket ensuring the couplings are engaged together correctly (top and bottom). **(NB: The motor can be placed in all directions on the motor bracket. However, ensure the cable terminals are accessible for electrical installation later.)**
2. If you are installing the motor at an angle of more than 30 degrees off vertical, the motor will require separate/ additional support.
3. Fasten the bolts holding the motor to the motor bracket with the above torque.
4. Check the drive shafts are engaged by rotating the propeller. **(NB: Rotating the propellers can be hard due to the gear reduction and the motor, however the propeller must be able to rotate via hand power.)**

(NB: The thruster motor assembly must be protected using suitable covering to avoid dust/debris ingress from fabrication/maintenance/shipbuilding operations. On completion of operations, the cover must be removed before operating the thruster.)

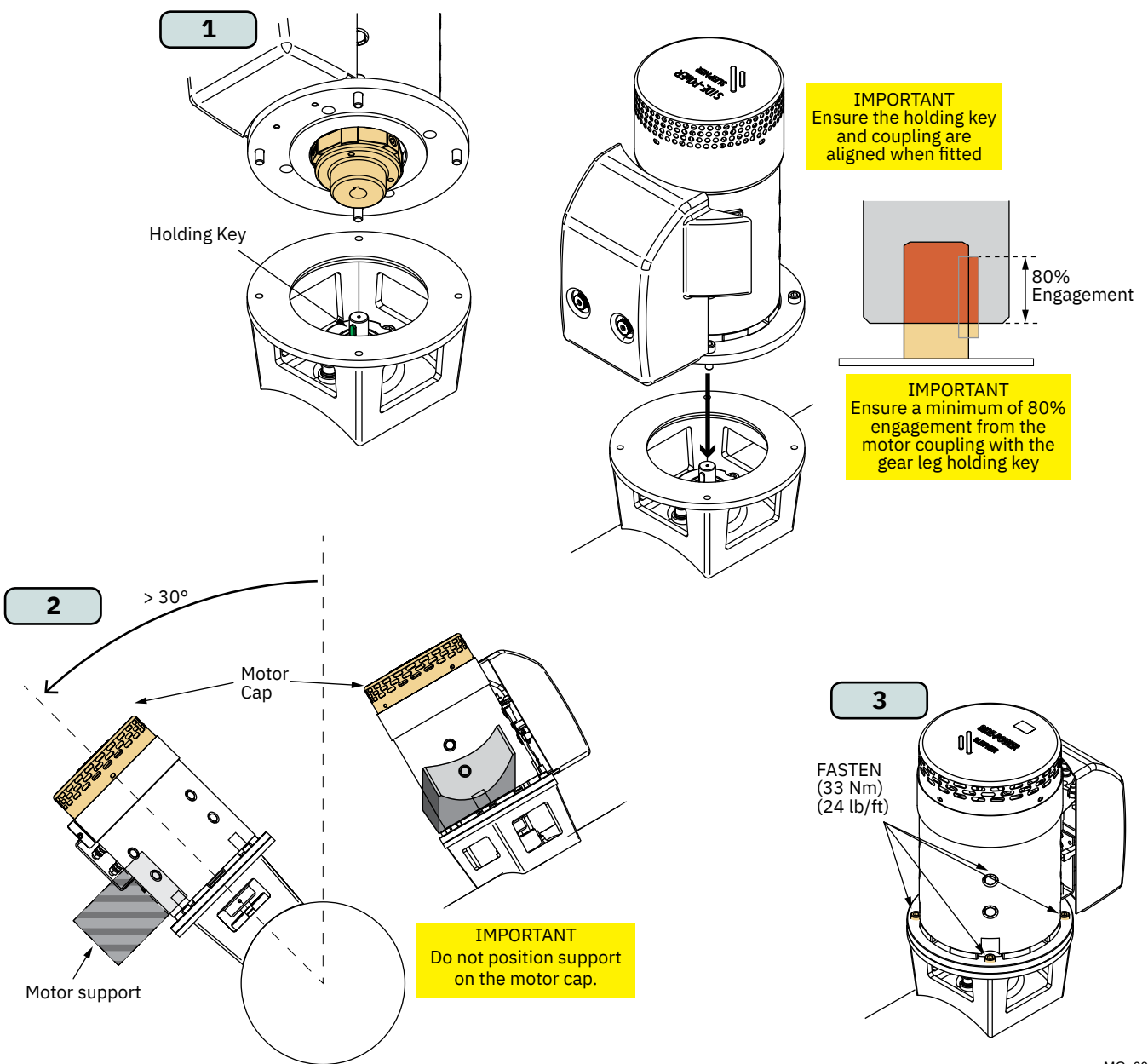

1. Plan the location of electrical components before starting with the electrical installation. Main electrical components will typically consist of battery, fuse, main switch, 20124A Voltage conversion unit 24V to 48V and thruster motor, see Wiring Diagram chapter for an overview.

The 20124A Voltage conversion unit 24V to 48V enables to run the 48V thruster from two 24V battery banks. It also enables charging with a standard 24V charger. See the wiring diagram topic for a system overview

Sleipner offers both manual main switches and Automatic Main Switches (AMS). Sleipner AMS is controlled by the control panel in addition to the option of manual operation. Turning on the control panel also turn on the automatic main switch. When the control panel is turned off the automatic main switch is turned off. This ensures that the control electronics and motor are only energized when the control panel is turned on. Sleipner offers AMS supporting either S-Link or ON/OFF control panels. Note that the AMS requires a separate power supply which should be protected by a dedicated fuse. Ensure to select an AMS with a voltage rating according to the chosen motor- and battery voltage.

Electrical products installed in gasoline engine spaces or other areas potentially exposed for explosive gases must be Ignition Protected. Products installed in such locations should conform to the ISO 8846, SAE J1171 or UL 1500 standard.

Common ground connection is required for dual thruster installations with two battery banks.

2. Estimate the total length of the power cables to determine the recommended cross-section. The total power cable length is defined as the distance from the positive battery terminal, via fuse, main switch, 20124A Voltage conversion unit 24V to 48V, thruster motor, and all the way back to the negative battery terminal.
3. Find the recommended power cable cross-section for the installation by using the estimated total power cable length and the table shown in the chapter Electrical Reference Guide.
4. Select the recommended fuse size by using the table shown in the chapter Electrical Reference Guide.
5. Use an appropriate dimensioned battery with Cold Cranking Amps (CCA) according to recommendations given in the Electrical Reference Guide chapter. Battery voltage must be compliant with the voltage rating of the thruster motor and control circuitry. The capacity and rated discharge current of the battery should be according to the rated nominal current drawn and the typical duty cycle for thruster operation. The nominal current drawn is listed in the Electrical Reference Guide chapter.

The actual voltage at the motor while running the thruster determines the motor RPM and thrust. Using a smaller cross-section than recommended or a low-capacity battery could reduce performance.

Installing a battery close to the thruster reduces the length of the power cables and potentially increases the performance, due to lower voltage drop in the power cables. For installations on large vessels with bow and stern thrusters or catamarans a dedicated battery for each thruster should be considered.

6. Install and connect the electrical components according to the applicable Wiring Diagram chapter.

For safety reasons it is always recommended to install a fuse and a main switch on the power cables and as close as possible to the positive battery terminal. The main switch must be installed such that it is easily accessible so that the thruster can be electrically disconnected to a safe state when not on-board or in the case of an emergency.

For dual thruster systems using only one battery bank a dedicated fuse and main switch should be installed for each thruster. These should be installed close to the battery bank.

Follow the instructions in the Motor Lug Connection chapter when fastening the power cables to the motor.

WARNING

After all electrical connections have been completed, turn off main switch and check the following with an ohmmeter:

1. There is no electrical connection between motor flange and the positive terminal on the motor.
2. There is no electrical connection between motor flange and the negative terminal on the motor.

If unsure contact skilled personnel.

Model Size	System Voltage	Nominal current	Min. battery CCA	Rec. fuse	Cross Section Guide for Power Cables													
					Unit	<7m total + & -		7-14m total + & -		15-21m total + & -		22-28m total + & -		28-35m total + & -		36-45m total + & -		
						Min.	Rec.	Min.	Rec.	Min.	Rec.	Min.	Rec.	Min.	Rec.	Min.	Rec.	
300/300TC	48V	400-450A	DIN: 400 SAE: 760 EN: 680	ANL 325	mm ²	50	70	50	70	70	95	95	120	120	120	120	2x95	2x120
					AWG	1/0	2/0	1/0	2/0	2/0	3/0	3/0	4/0	4/0	4/0	4/0	2x3/0	2x4/0

Motor lug connection

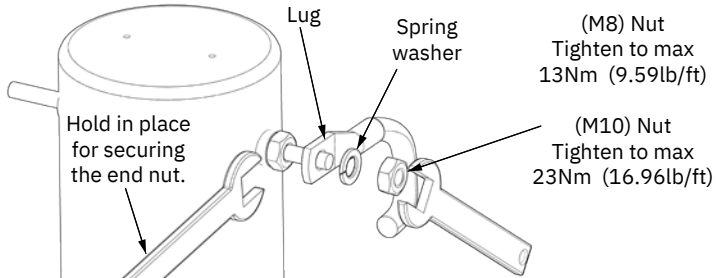

IMPORTANT
Do NOT use washers between lugs, this causes overheating and fire. Spring washers must be placed in the outer position before tightening nut.

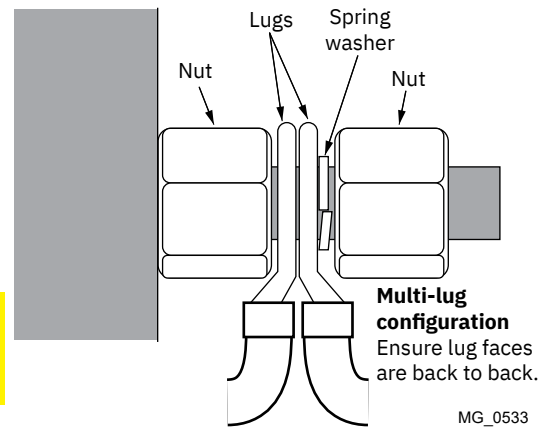

Automatic Main Switch Wiring Diagram 48V Thruster

The top wiring diagram is for a single bow or stern thruster system.

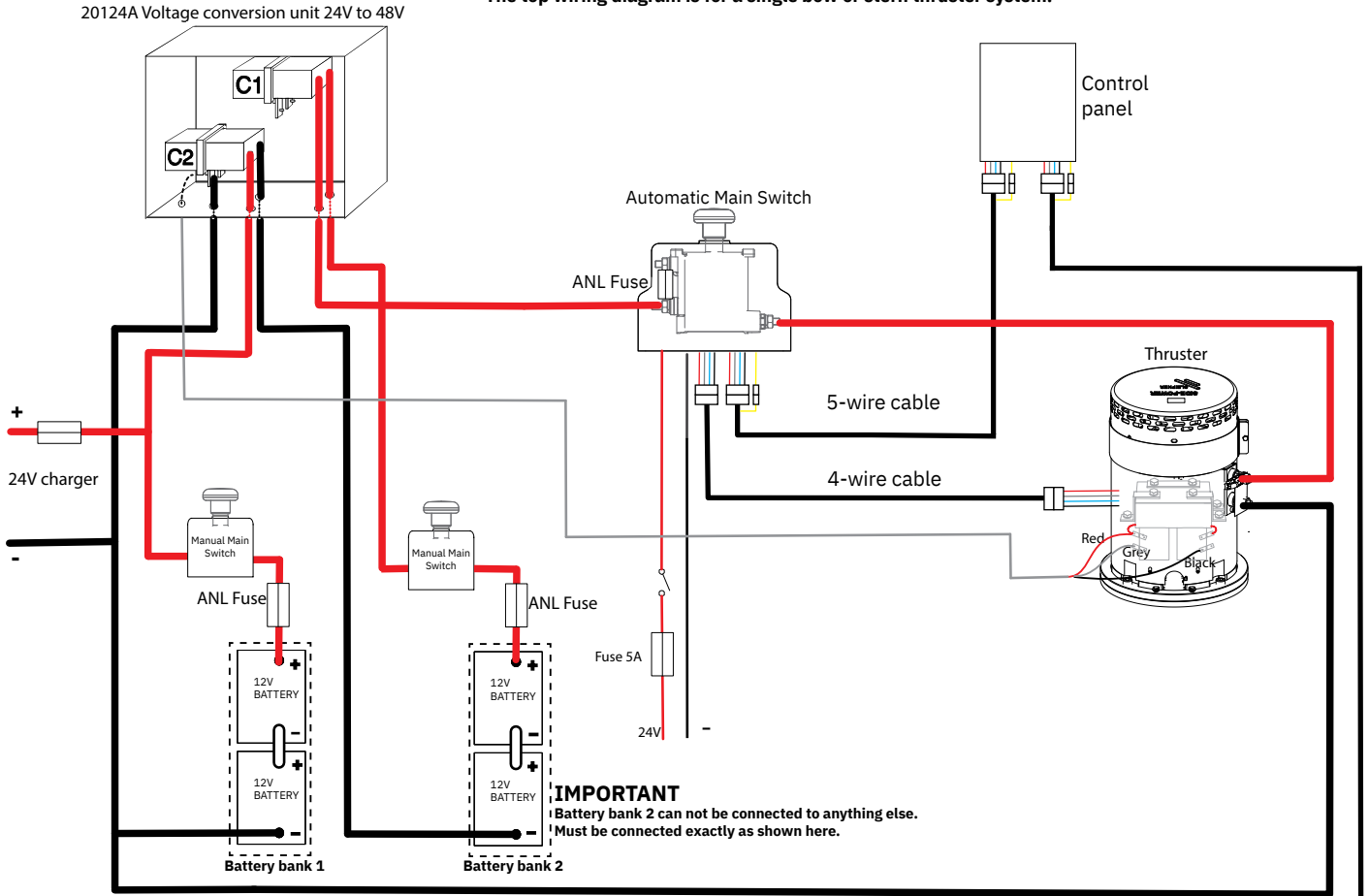

The top and bottom wiring diagram is for a dual thruster system, for example a bow and stern installation.

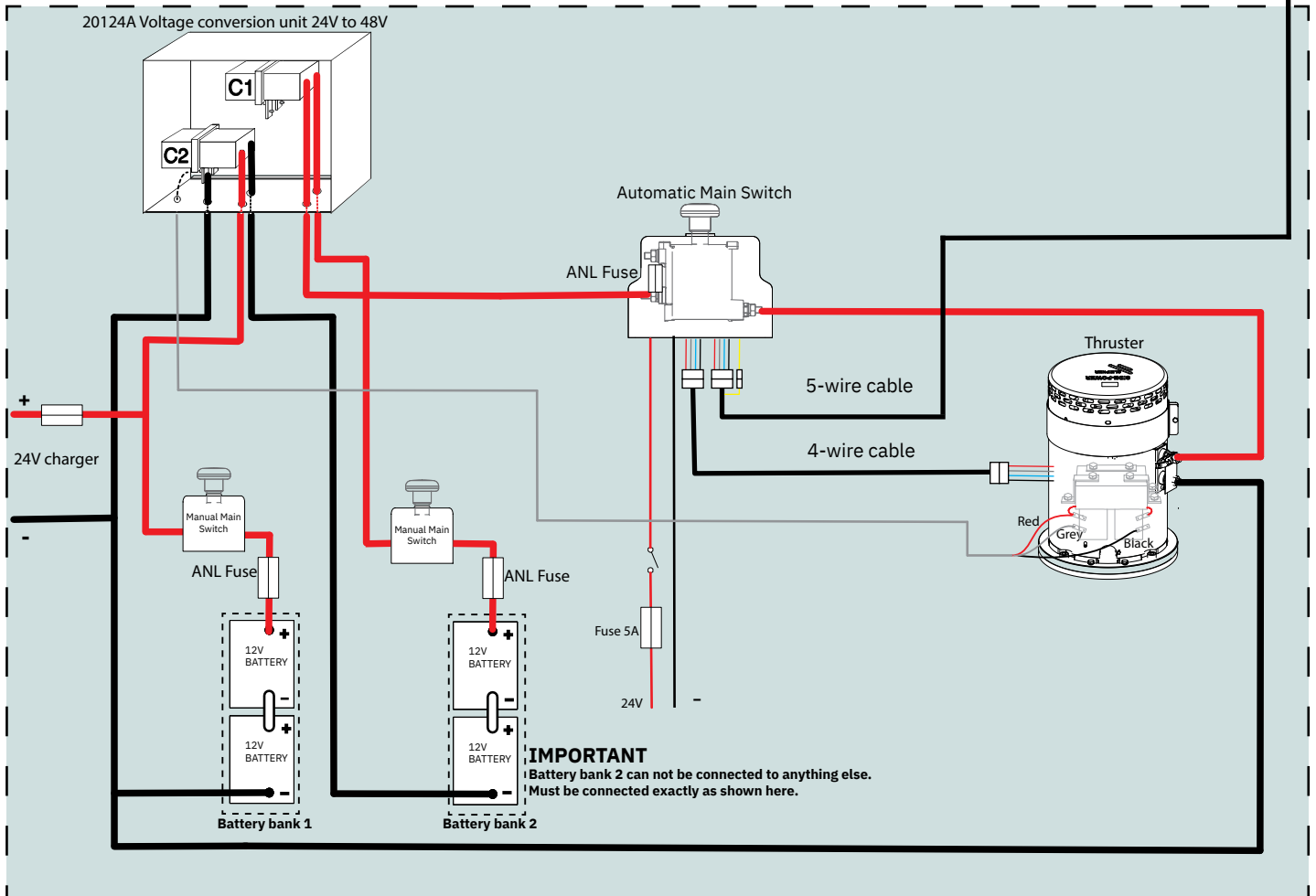

MG_0927

S-Link is a CAN-based control system used for communication between Sleipner products installed on a vessel. The system uses BACKBONE Cables as a common power and communication bus with separate SPUR Cables to each connected unit. Only one S-Link POWER cable shall be connected to the BACKBONE Cable. Units with low power consumption are powered directly from the S-Link bus.

Main advantages of S-Link system:

- Compact and waterproof plugs.
- BACKBONE and SPUR Cables have different colour coding and keying to ensure correct and easy installation. BACKBONE Cables have blue connectors and SPUR Cables have green connectors.
- Different cable lengths and BACKBONE Extenders make the system scalable and flexible to install.

Installation of S-Link cables:

Select appropriate cables to keep the length of BACKBONE- and SPUR Cables to a minimum. In case of planned installation with total BACKBONE Cable length exceeding 100 meters please consult your local distributor. The S-Link cables should be properly fastened when installed to avoid sharp bend radius, cable chafing and undesired strain on connectors. Locking mechanism on connectors must be fully closed. To ensure long lifetime, cables, T-Connectors and Extenders should not be located so that they are permanently immersed in water or other fluids. It is also recommended to install cables such that water and condensation do not run along the cables and into the connectors.

The POWER Cable should ideally be connected around the middle of the BACKBONE bus to ensure an equal voltage drop at each end of the BACKBONE Cable. The yellow and black wire in the POWER Cable shall be connected to GND and the red wire connected to +12VDC or +24VDC.

To reduce the risk of interference, avoid routing the S-Link cables close to equipment such as radio transmitters, antennas or high voltage cables. The backbone must be terminated at each end with the END Terminator.

SPUR cables can be left unterminated to prepare for the installation of future additional equipment. In such cases, ensure to protect open connectors from water and moisture to avoid corrosion in the connectors.

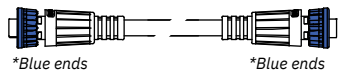

BACKBONE Cable

Forms the communication and power bus throughout a vessel. Available in different standard lengths.

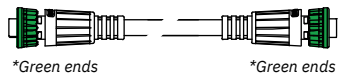

SPUR Cable

Used to connect S-Link compliant products to the backbone cable. One SPUR Cable must be used for each connected component, with no exceptions. Recommended to be as short as practically possible. Available in different standard lengths.

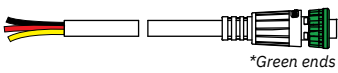

POWER Cable

Required in all installations for connection of BACKBONE Cable to a power supply and should be protected with a 2A fuse.

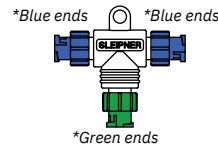

T-Connector

Used for connection of SPUR or POWER Cable to the BACKBONE Cable. One T-Connector for each connected cable.



BACKBONE Extender

Connects two BACKBONE Cables to extend the length.

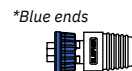

END Terminator

Must be one at each end of the BACKBONE bus.

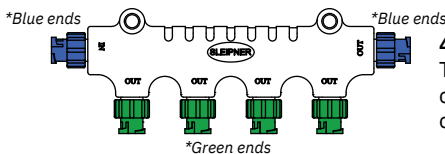

4-Port T-Connector

The 4-PORT T-connector allows multiple SPUR Cables to be connected. The 4-PORT T-connector comes with two sealing caps to protect unused ports.

S-Link installation example

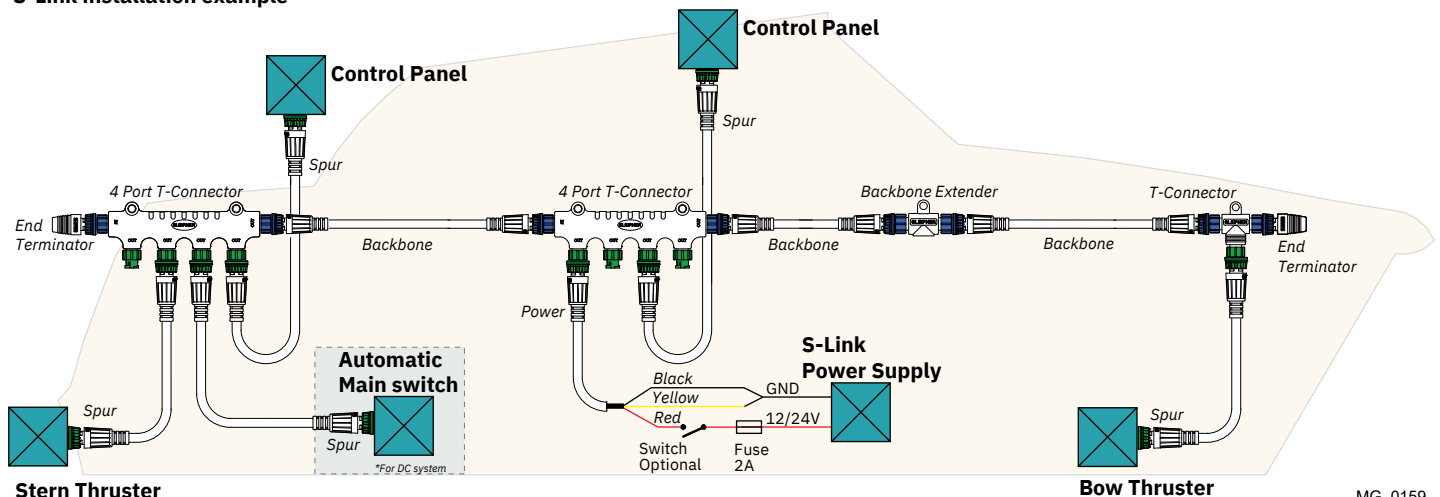

MG_0159

- The bolts holding the gear leg and main bracket together are tightened correctly.
- The bolts holding the motor to its bracket are tightened correctly.
- All electrical connections are clean, dry and tight, and the correct cable, fuse and main switch size.
- Check that there is no electrical connection between the electro motor body and positive terminal on the motor, and between the electro motor body and the negative terminal on the motor with an ohm meter.
- Anti-fouling has been applied to the gear leg and propeller but NOT anodes, sealing/ rubber fittings or propeller shafts.
- Propeller is fastened correctly to the shaft.
- Propeller turns freely in tunnel.
- The anode and/ or holding screw is tightened well with thread glue.
- Check the boat for potential water leakage around installation areas.
- Correct drive direction as per control panel.
- User Manual is supplied to the owner.

The thruster has been installed as per the instructions in this manual and all points in checklist above have been controlled.

Signed:

Date:

Thruster type:

Serial number:.....

Date of delivery:.....

Correct drive direction as per control panel:

The compartment for the thruster has been isolated from general bilge water and has no obvious or suspected risks for flooding:

.....
.....
.....

Other comments by installer:

.....
.....

Find your local professional dealer from our certified worldwide network for expert service and support. visit our website www.sleipnergrou.com/support

Product spare parts and additional resources

For additional supporting documentation, we advise you to visit our website www.sleipnergrou.com and find your Sleipner product.

Warranty statement

1. Sleipner Motor AS (The “Warrantor”) warrants that the equipment (parts, materials, and embedded software of products) manufactured by the Warrantor is free from defects in workmanship and materials for purpose for which the equipment is intended and under normal use and maintenance service (the “Warranty”).
2. This Warranty is in effect for two years (Leisure Use) or one year (Commercial and other Non-leisure Use) from the date of delivery/purchase by the end user, with the following exceptions;
 - (a) For demonstration vessels, or vessels kept on the water, the dealer is considered as the end user from 6 months after their launch of the vessel;
 - (b) The warranty period starts no later than 18 months after the first launch of the vessel.
 Please note that the boat manufacturer and dealer must pay particular attention to correct maintenance and service both by the products manuals as well as general good practice for the location the boat is kept in the period the boat is in their care. In cases where the 6 and 18 months grace periods for boat builders and dealers are passed, it is possible to obtain a full warranty upon inspection and approval of the warrantor or such representative.
3. Certain parts, classified as wearable or service parts, are not covered by the warranty. A failure to follow the required maintenance and service work as described in the product manual render all warranty on parts or components directly or indirectly affected by this void. Please also note that for some parts, time is also a factor separately from actual operational hours.
4. This Warranty is transferable and covers the equipment for the specified warranty period.
5. The warranty does not apply to defects or damages caused by faulty installation or hook-up, abuse or misuse of the equipment including exposure to excessive heat, salt or fresh water spray, or water immersion except for equipment specifically designed as waterproof.
6. In case the equipment seems to be defective, the warranty holder (the “Claimant”) must do the following to make a claim:
 - (a) Contact the dealer or service centre where the equipment was purchased and make the claim. Alternatively, the Claimant can make the claim to a dealer or service centre found at www.sleipnergrou.com. The Claimant must present a detailed written statement of the nature and circumstances of the defect, to the best of the Claimant’s knowledge, including product identification and serial nbr., the date and place of purchase and the name and address of the installer. Proof of purchase date should be included with the claim, to verify that the warranty period has not expired;
 - (b) Make the equipment available for troubleshooting and repair, with direct and workable access, including dismantling of furnishings or similar, if any, either at the premises of the Warrantor or an authorised service representative approved by the Warrantor. Equipment can only be returned to the Warrantor or an authorised service representative for repair following a pre-approval by the Warrantor’s Help Desk and if so, with the Return Authorisation Number visible postage/shipping prepaid and at the expense of the Claimant.
7. Examination and handling of the warranty claim:
 - (a) If upon the Warrantor’s or authorised service Representative’s examination, the defect is determined to result from defective material or workmanship in the warranty period, the equipment will be repaired or replaced at the Warrantor’s option without charge, and returned to the Purchaser at the Warrantor’s expense. If, on the other hand, the claim is determined to result from circumstances such as described in section 4 above or a result of wear and tear exceeding that for which the equipment is intended (e.g. commercial use of equipment intended for leisure use), the costs for the troubleshooting and repair shall be borne by the Claimant;
 - (b) No refund of the purchase price will be granted to the Claimant, unless the Warrantor is unable to remedy the defect after having a reasonable number of opportunities to do so. In the event that attempts to remedy the defect have failed, the Claimant may claim a refund of the purchase price, provided that the Claimant submits a statement in writing from a professional boating equipment supplier that the installation instructions of the Installation and Operation Manual have been complied with and that the defect remains.
8. Warranty service shall be performed only by the Warrantor, or an authorised service representative, and any attempt to remedy the defect by anyone else shall render this warranty void.
9. No other warranty is given beyond those described above, implied or otherwise, including any implied warranty of merchantability, fitness for a particular purpose other than the purpose for which the equipment is intended, and any other obligations on the part of the Warrantor or its employees and representatives.
10. There shall be no responsibility or liability whatsoever on the part of the Warrantor or its employees and representatives based on this Warranty for injury to any person or persons, or damage to property, loss of income or profit, or any other incidental, consequential or resulting damage or cost claimed to have been incurred through the use or sale of the equipment, including any possible failure or malfunction of the equipment or damages arising from collision with other vessels or objects.
11. This warranty gives you specific legal rights, and you may also have other rights which vary from country to country.

Patents

At Sleipner we continually reinvest to develop and offer the latest technology in marine advancements. To see the many unique designs we have patented visit our website www.sleipnergrou.com/patents

A series of horizontal dotted lines for writing notes.

Dotted lines for writing notes.

Dotted lines for note-taking.

© **Sleipner Group**, All rights reserved
The information given in the document
was right at the time it was published.
However, Sleipner Group cannot
accept liability for any inaccuracies or
omissions it may contain. Continuous
product improvement may change the
product specifications without notice.
Therefore, Sleipner Group cannot accept
liability for any possible differences
between product and document.

Learn more about our products at
www.sleipnergroun.com



SLEIPNER MOTOR AS

P.O. Box 519

N-1612 Fredrikstad

Norway

www.sleipnergroun.com

Made in Norway